

User Manual

使用说明书

NUX Drum System DIGITAL DRUM KIT DM-210 电子鼓

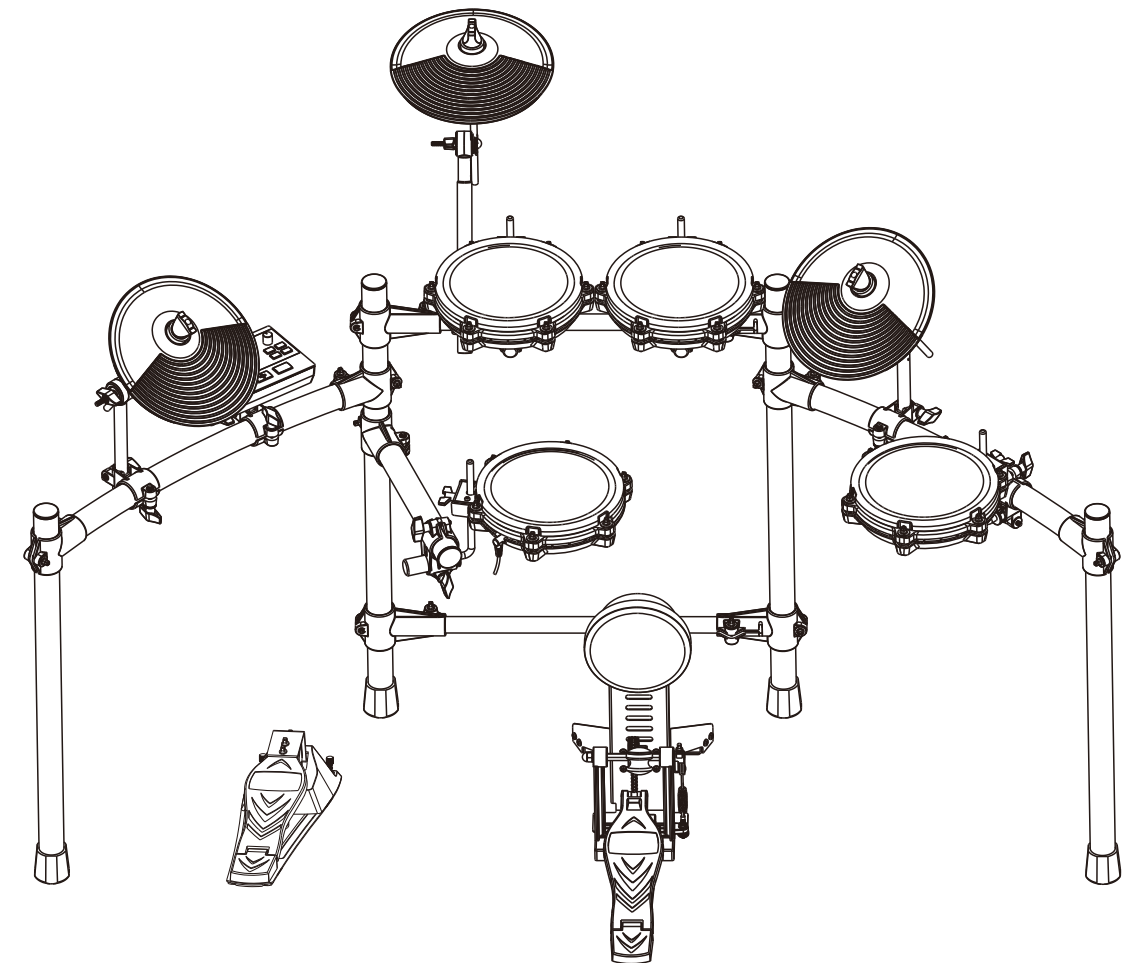

NUX

Cherub Technology Co.,Ltd

深圳市蔚科电子科技有限公司

www.nuxefx.com

© 2020 Cherub Technology-All rights reserved.

No part of this publication may be reproduced in any form without prior written permission of Cherub Technology.

USING THE UNIT SAFELY

INSTRUCTIONS FOR THE PREVENTION OF FIRE, ELECTRIC SHOCK, OR INJURY TO PERSONS

About ⚠️ WARNING and ⚠️ CAUTION Notices

⚠️ WARNING
Used for instructions intended to alert the user to the risk of death or severe injury should the unit be used improperly.

About the Symbol

⚠️ CAUTION
Used for instructions intended to alert the user to the risk of injury or material damage should the unit be used improperly.
* Material damage refers to damage or other adverse effects caused with respect to the home and all its furnishings, as well to domestic animals or pets.

ALWAYS OBSERVE THE FOLLOWING

⚠️ WARNING

- Before using this unit, make sure to read the instructions below and the Owner's Manual.
- Do not open (or modify in any way) the unit or its AC adaptor.
- Do not attempt to repair the unit, or replace parts within it (except when this manual provides specific instructions directing you to do so). Refer all servicing to your retailer, the nearest NUX Service Center.
- Never use or store the unit in places that are:
 - Subject to temperature extremes (e.g., direct sunlight in an enclosed vehicle, near a heating duct, on top of heat-generating equipment); or are
 - Damp (e.g., baths, washrooms, on wet floors); or Are
 - Humid; or Are
 - Exposed to rain; or Are
 - Dusty; or Are
 - Subject to high levels of vibration.
- This unit may be installed on a stand using a Clamp.
- When installing the unit on a stand with a clamp, the stand must not be placed in an unstable location or on an incline, but in a level and stable position. Even if a stand is not used, make sure that the unit is placed in a stable location.

⚠️ WARNING

- Be sure to use only the AC adaptor supplied with the unit. Also, make sure the line voltage at the installation matches the input voltage specified on the AC adaptor's body. Other AC adaptors may use a different polarity, or be designed for a different voltage, so their use could result in damage, malfunction, or electric shock.
- Do not excessively twist or bend the power cord, nor place heavy objects on it. Doing so can damage the cord, producing severed elements and short circuits. Damaged cords are fire and shock Hazards!
- This unit, either alone or in combination with an amplifier and headphones or speakers, may be capable of producing sound levels that could cause permanent hearing loss. Do not operate for a long period of time at a high volume level, or at a level that is uncomfortable. If you experience any hearing loss or ringing in the ears, you should immediately stop using the unit, and consult an Audiologist.
- Do not allow any objects (e.g., flammable material, coins, pins); or liquids of any kind (water, soft drinks, etc.) to penetrate the unit.

⚠️ WARNING

- Immediately turn the power off, remove the AC adaptor from the outlet, and request servicing by your retailer, the nearest NUX Service Center.
- The AC adaptor or the power-supply cord has been damaged; or
- If smoke or an unusual odor occurs
- Objects have fallen into, or liquid has been spilled onto the unit; or
- The unit has been exposed to rain (or otherwise has become wet); or
- The unit does not appear to operate normally or exhibits a marked change in performance.

- In households with small children, an adult should provide supervision until the child is capable of following all the rules essential for the safe operation of the unit.

- Protect the unit from strong impact. (Do not drop it!)

- Do not force the unit's power-supply cord to share an outlet with an unreasonable number of other devices. Be especially careful when using extension cords—the total power used by all devices you have connected to the extension cord's outlet must never exceed the power rating (watts/amperes) for the extension cord. Excessive loads can cause the insulation on the cord to heat up and eventually melt through.

- Before using the unit in a foreign country, consult with your retailer, the nearest NUX Service Center.

⚠️ CAUTION

- The unit and the AC adaptor should be located so their location or position does not interfere with their proper ventilation.

- Always grasp only the output plug or the body of the AC adaptor when plugging into, or unplugging from, this unit or an outlet.

- Any accumulation of dust between the AC adaptor and the power outlet can result in poor insulation and lead to fire. Periodically wipe away such dust with a dry cloth. Also, disconnect the power plug from the power outlet whenever the unit is to remain unused for an extended period of time.

- Try to prevent cords and cables from becoming entangled. Also, all cords and cables should be placed so they are out of the reach of children.

- Never climb on top of, nor place heavy objects on the unit.

- Never handle the AC adaptor body, or its output plugs, with wet hands when plugging into, or unplugging from, an outlet or this unit.

- If you need to move the instrument, take note of the precautions listed below. Make sure to have a firm grip, to protect yourself from injury and the instrument from damage.
 - Check to make sure that the clamp that fixes the unit to the stand has not become loose. Fasten them again securely whenever you notice any loosening.
 - Disconnect the power cord.
 - Disconnect all cords coming from external devices.

- Before cleaning the unit, turn off the power and unplug the AC adaptor from the outlet.

- Whenever you suspect the possibility of lightning in your area, disconnect the AC adaptor from the outlet.

- Should you remove security screws, make sure to put them in a safe place out of children's reach, so there is no chance of them being swallowed accidentally.

CONTENTS

Assembly diagram	04
Finish	07
Module control panel	08
Connect external devices	09
Screen display	10
Ready to play	11
Function operation	14
Switch drum kit	14
Drum pad setup	14
Effect	16
Demo song	16
Click	16
Recording	16
Coach	17
System	19
MIDI Implementation chart	20
Drum kit name	20
Specifications	21

ASSEMBLY DIAGRAM

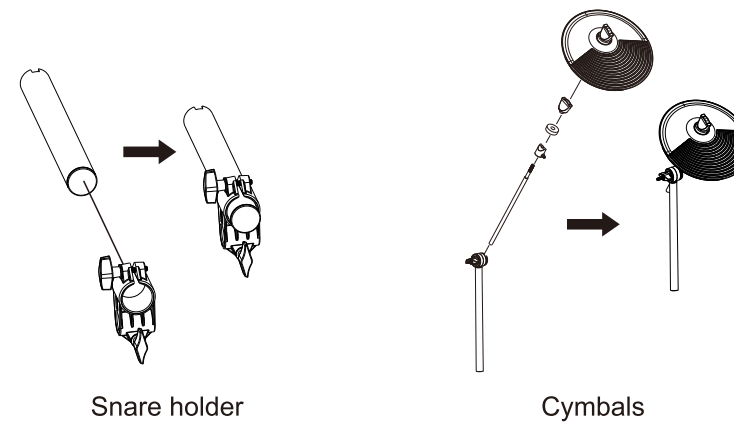
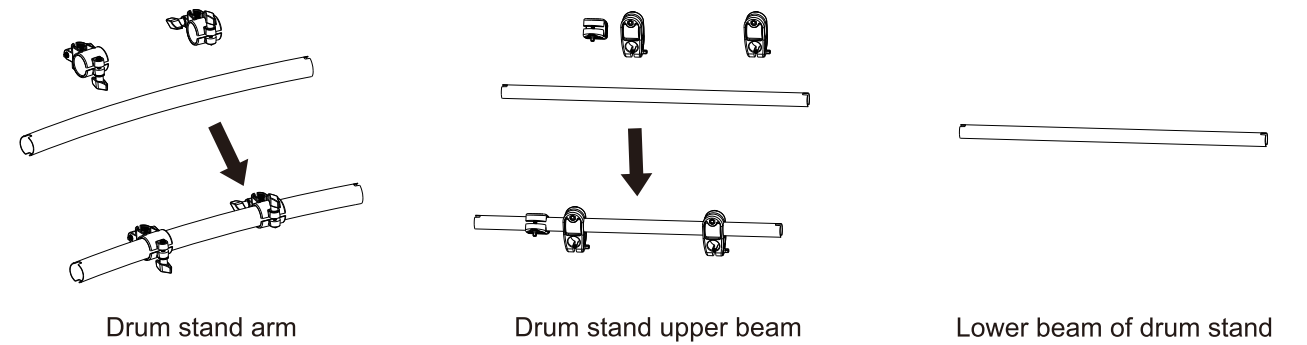
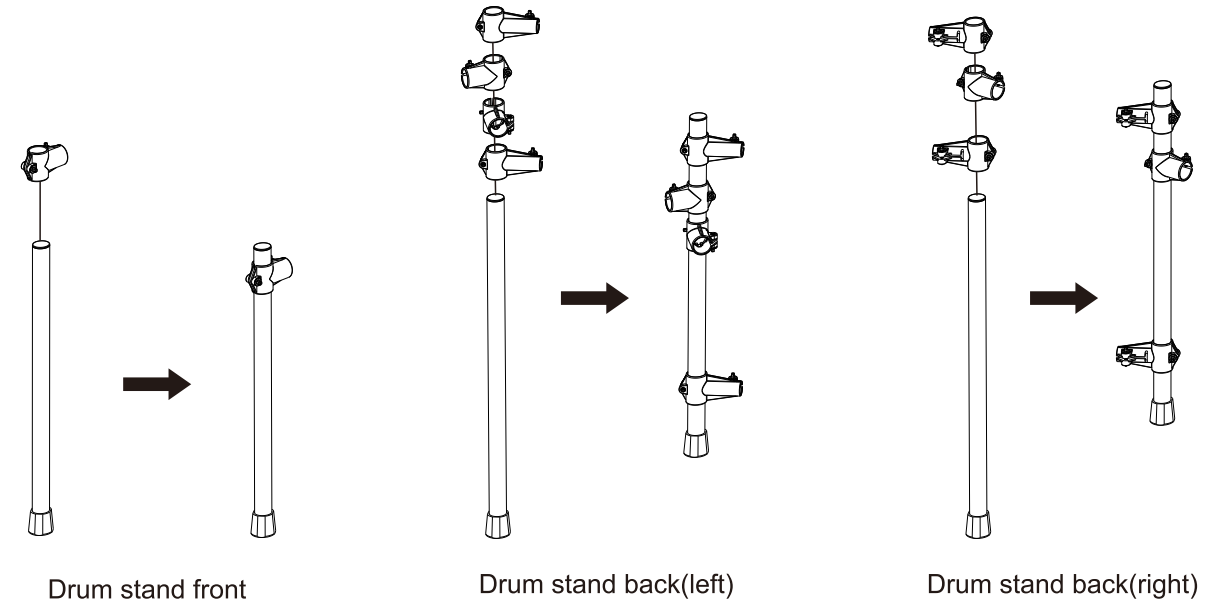

ASSEMBLY DIAGRAM

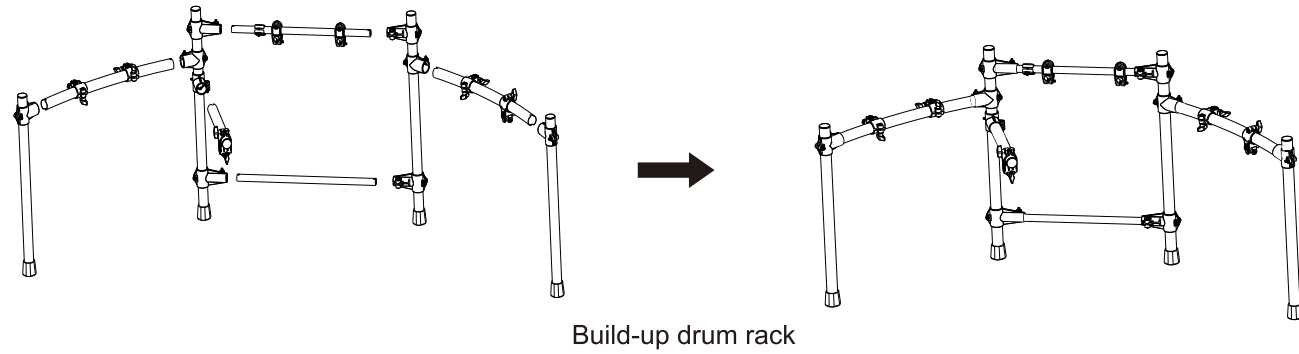

Build-up drum rack

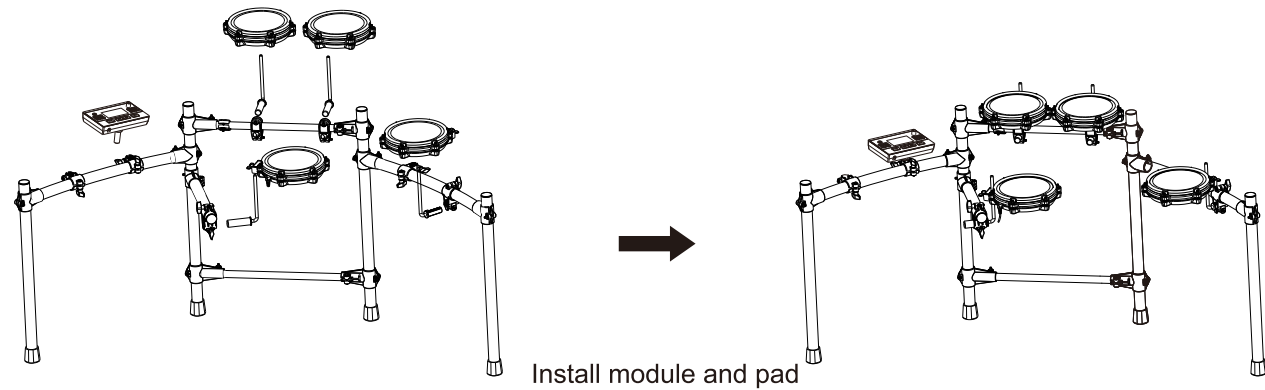

Install module and pad

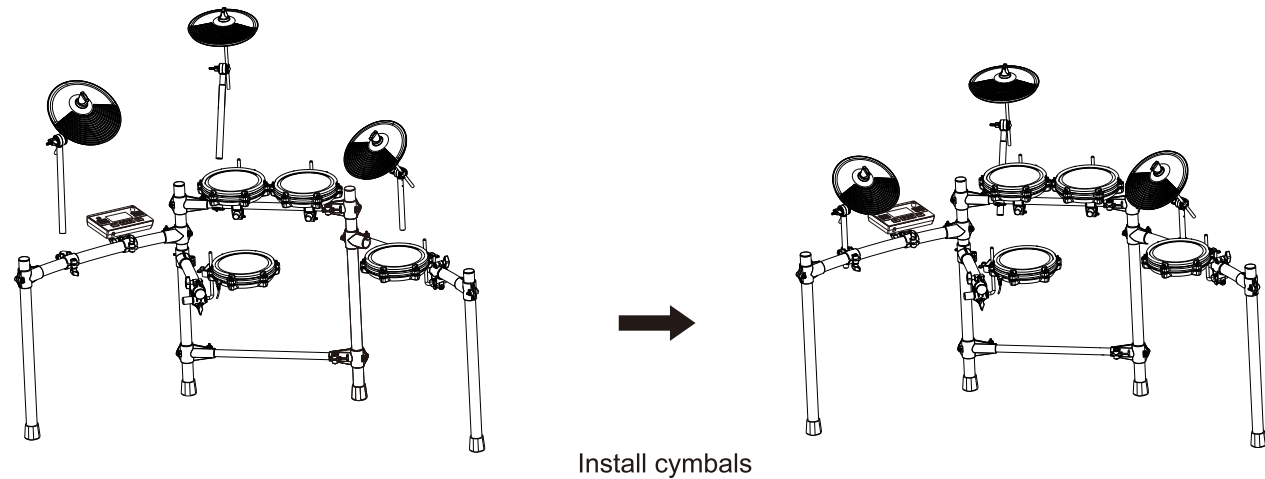

Install cymbals

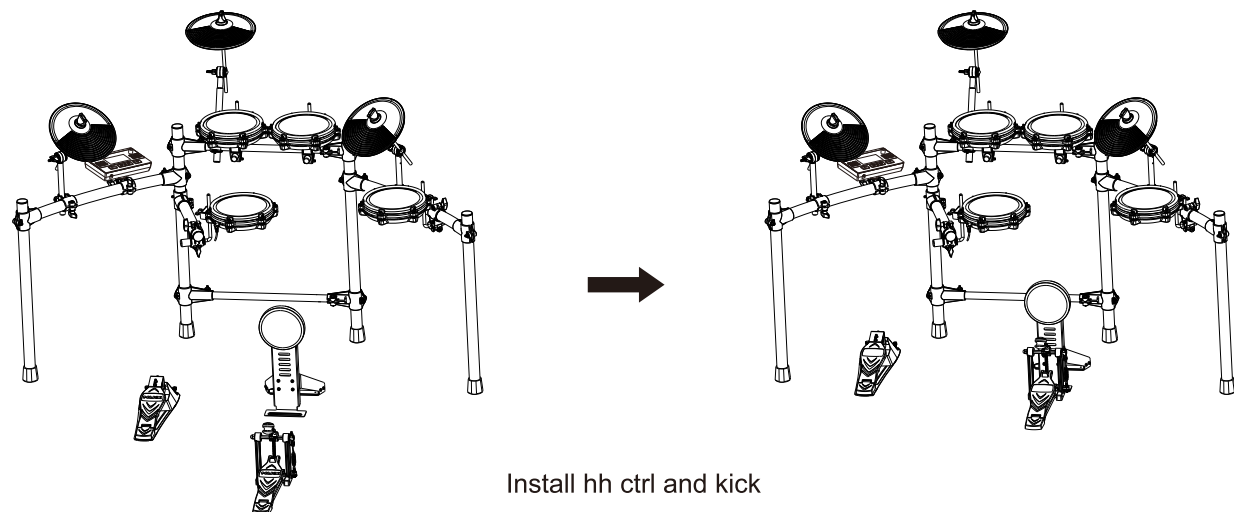

Install hh ctrl and kick

ASSEMBLY DIAGRAM

Cable connection

1. Connect the cable to the module.

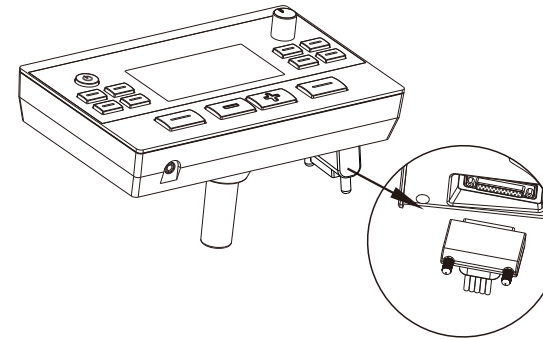

3. Connect the hh ctrl and kick.

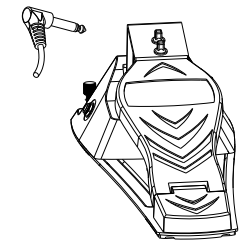

2. The label on the cable indicates the drum pad to be connected.

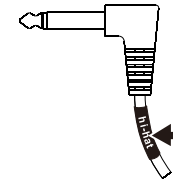

In order to prevent equipment damage, please shut down during the connection process.

Connect the drum pad:

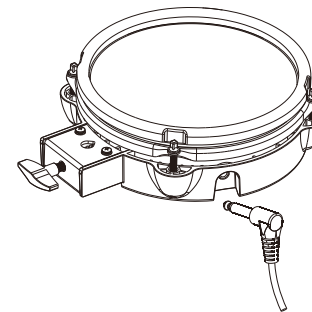

Connect the cymbal pad:

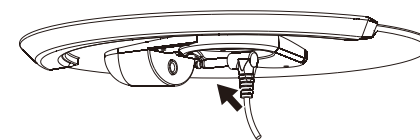

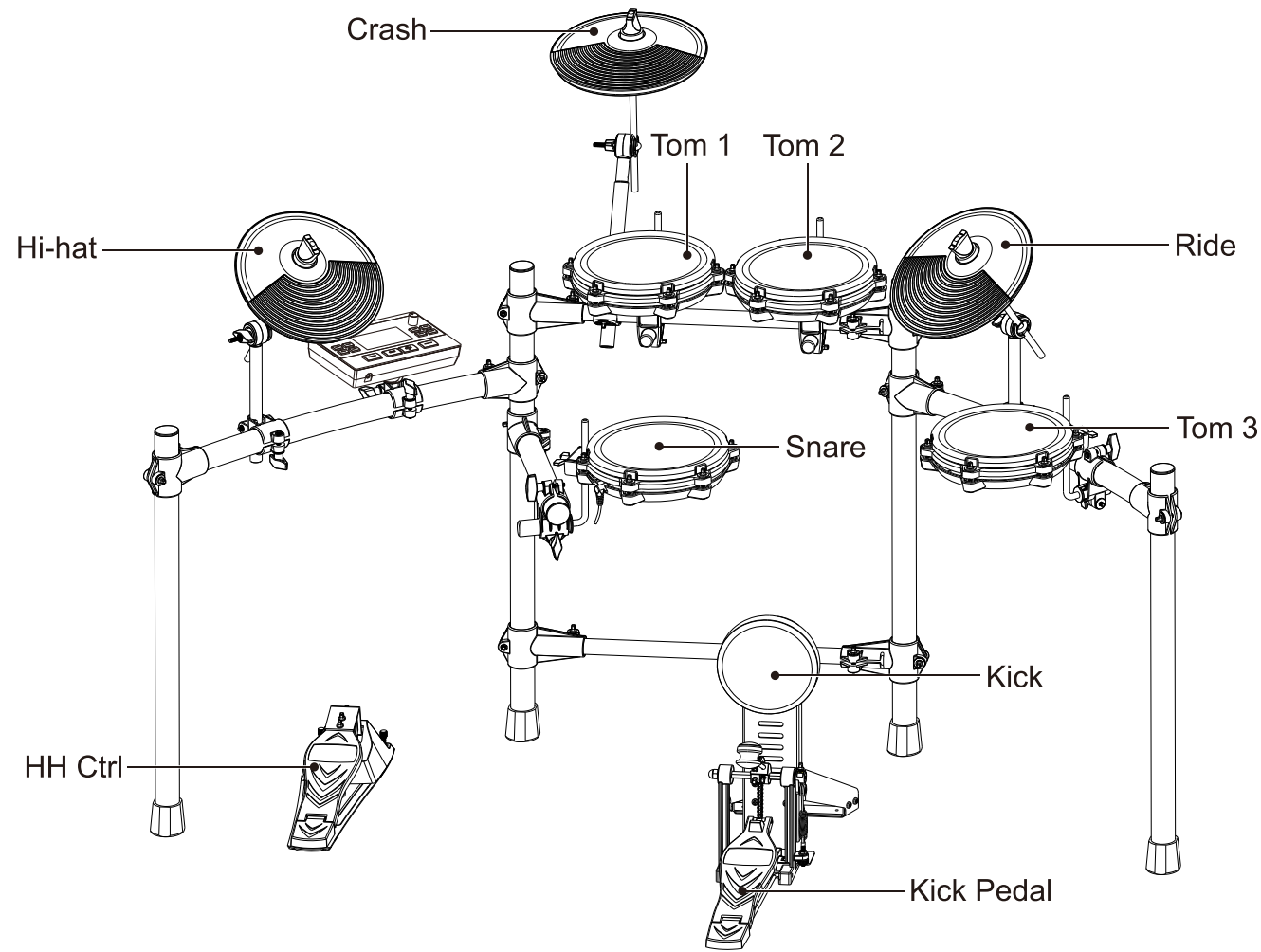

- | | |
|-------------------------|--|
| 1. Screen display | 9. Volume adjustment |
| 2. Power on/off | 10. Recording |
| 3. Click on/off | 11. Play/stop |
| 4. Drum kit mode | 12. Mute the drum sound into demo song |
| 5. Reverb on/off | 13. Demo song |
| 6. Coach on/off | 14. Parameter adjustment |
| 7. Parameter adjustment | 15. OK |
| 8. Menu | 16. Phone |

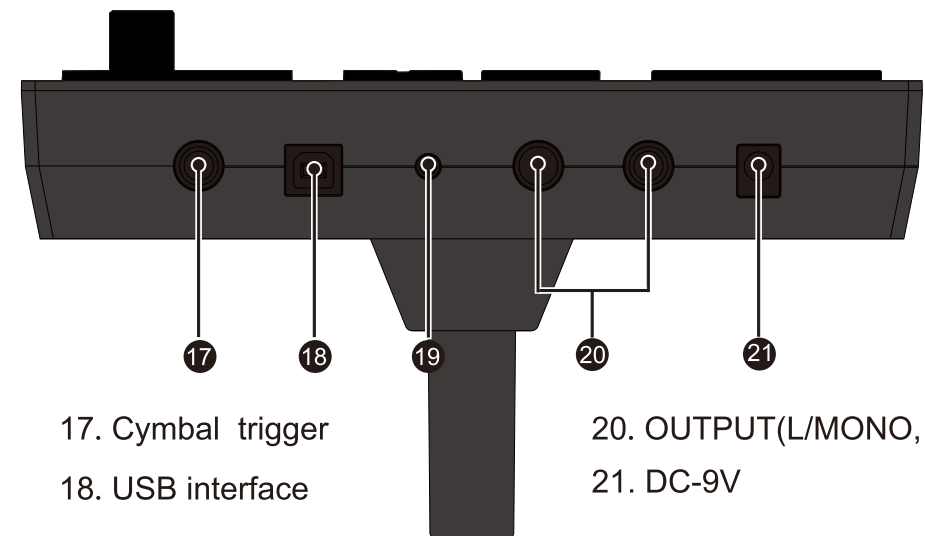

- | | |
|----------------------|-----------------------|
| 17. Cymbal trigger | 20. OUTPUT(L/MONO, R) |
| 18. USB interface | 21. DC-9V |
| 19. AUX IN interface | |

CONNECT EXTERNAL DEVICES

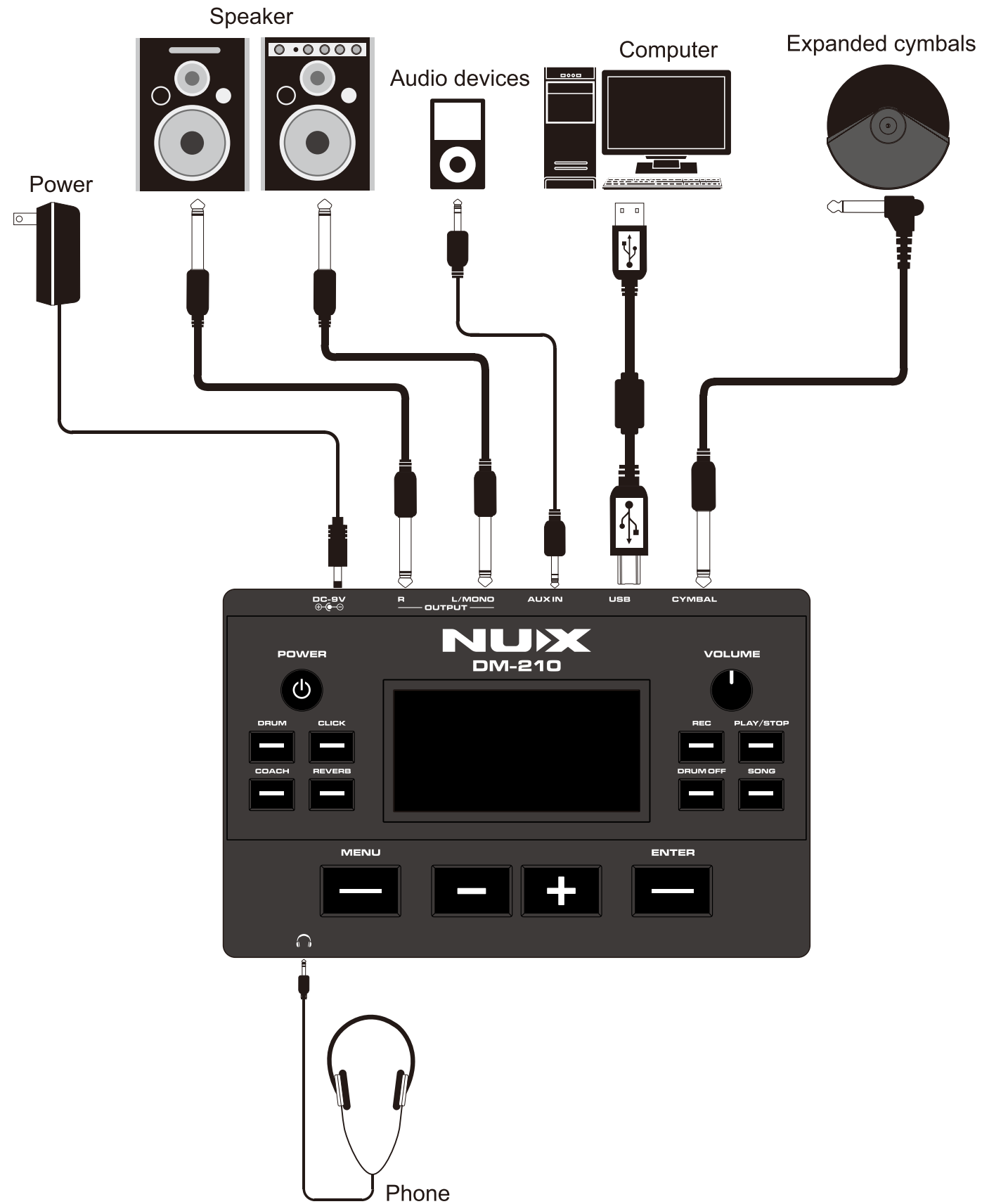

WARNING:
In order to prevent equipment damage, please shut down during the connection process.

MODULE CONTROL PANEL

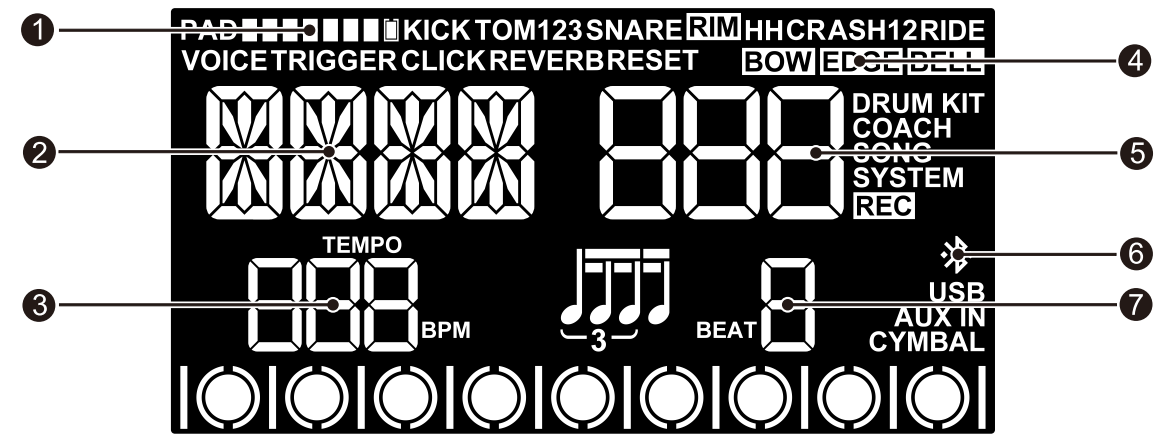

- | | |
|---------------------------|----------------------|
| 1. Power display | 5. Parameter display |
| 2. Parameter name display | 6. Blue-tooth |
| 3. Tempo | 7. Beat |
| 4. Part display | |

READY TO PLAY

*Turn on power

1. Adjust the volume to lowest.
2. Adjust the amp volume to lowest.
3. Turn the power.



When the power is turned on, a weak sound may be heard, which is normal.

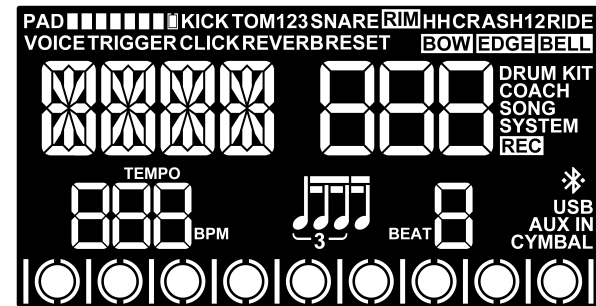

4. Hit the pad and adjust the volume as you need.

* Turn off power

1. Adjust the amp volume to lowest.
2. Turn off the amp.
3. Turn the power of DM-210.



READY TO PLAY

*Snare

Head shot
Hit the head.

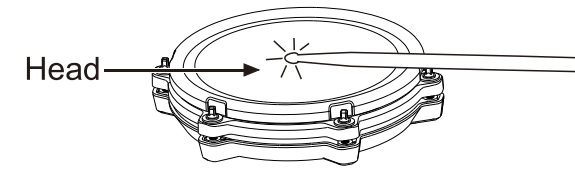

Cross stick

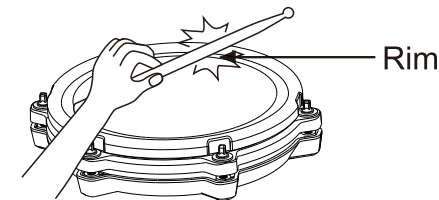

* Tom

Head shot
Hit the head.

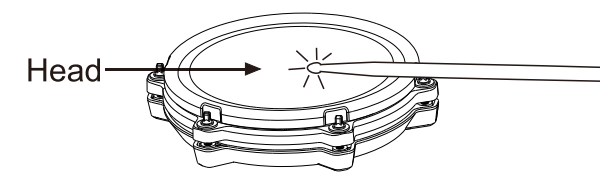

Rim click
Hit the rim.

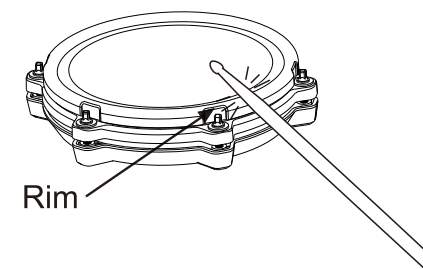

* Kick

Strike down the kick pedal.

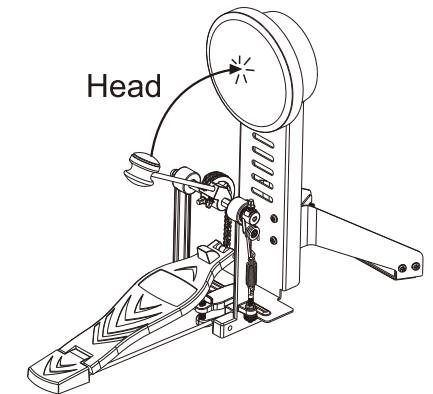

*Crash Ride

Bow shot
Hit the bow.

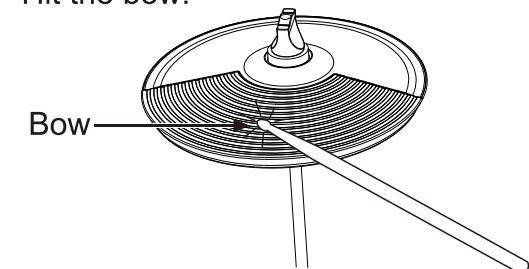

Edge shot
Hit the edge.

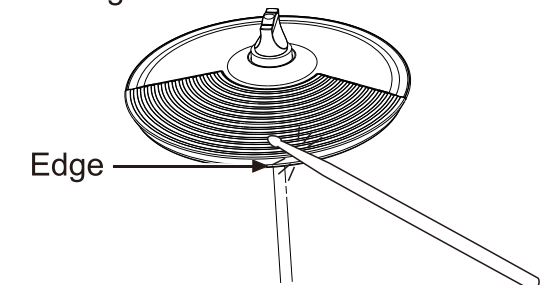

Choke

Choke the cymbal's edge with the hand immediately after hitting the cymbal will mute the sound. The choke function only works when you grasp in the area.

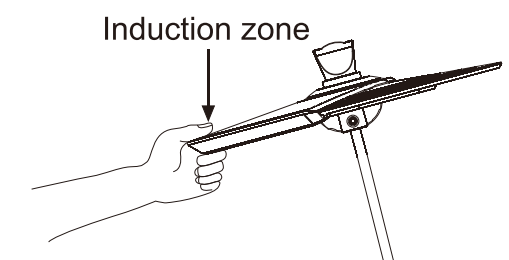

READY TO PLAY

*Hi-hat

The hi-hat sound will change smoothly between open and closed depending on pressure applied to the hi-hat control pedal.

Bow shot

Hit the bow.

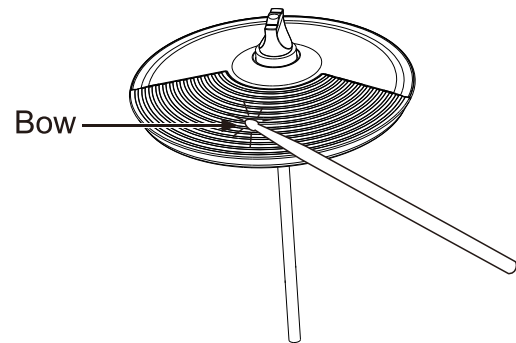

Choke

Choke the cymbal's edge with the hand immediately after hitting the cymbal will mute the sound. The choke function only works when you grasp in the area.

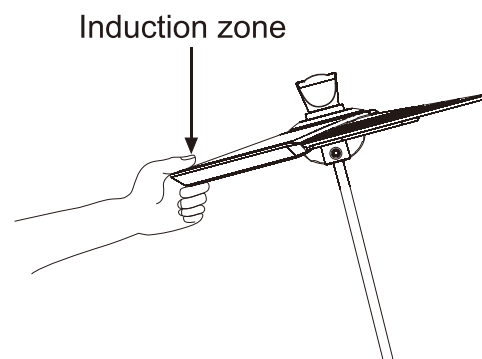

*HH Ctrl

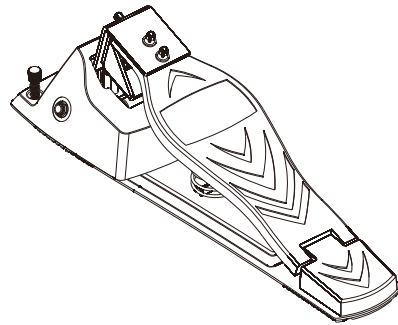

Open hi-hat

Hit the hi-hat without pressing the pedal.

Close hi-hat

Hit the hi-hat with the pedal pressed.

FUNCTION OPERATION

Switch the drum kit

*Boot into Drum Kit

1. Use the - + button to switch the drum kit.
2. Press the drum button to enter the drum kit mode in any mode.

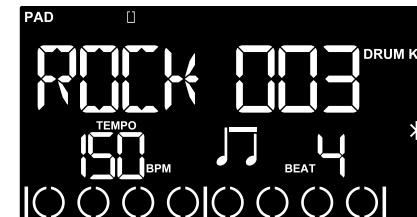

Drum pad setup

1. Press the MENU button to enter menu function in drum kit mode.
2. Use the - + button to select voice or TRIG (trigger) to adjust the drum pad parameters, press the ok button to confirm, and press the MENU button to return to the main menu.

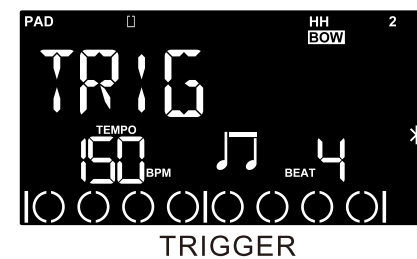

*Voice

1. In VOICE function, hit any drum pad to choose the pad you need to adjust.
2. Use the OK button to select the parameter you want to adjust.

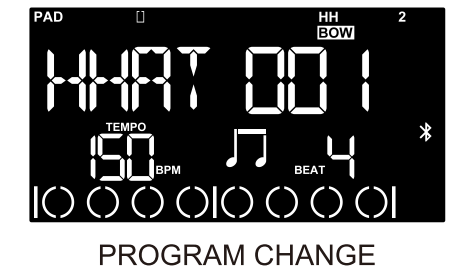
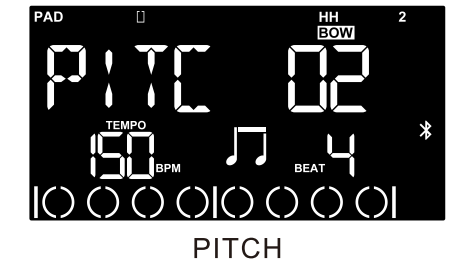

3. Adjust the parameters through the -+ keys, press the MENU key to return after adjustment, the parameters are automatically saved.

*Trig

1. In the TRIG interface, hit any pad to select the pad you want to adjust.
2. Use the OK button to select the parameter you want to adjust.
3. Adjust the parameters through the -+ keys, press the MENU key to return after adjustment, the parameters are automatically saved.

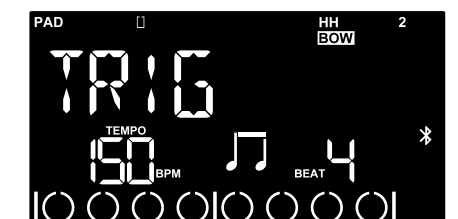

FUNCTION OPERATION

Parameter	Adjustment range	Parameter description
SENSITIVITY	01-99	Adjust the drum sensitivity, the higher the sensitivity, the louder sound will be produced even if the pad is tapped lightly. The lower the sensitivity, the smaller the volume will be produced even if you tap hard. Try and adjust the sensitivity that suits your combat habits.

THRESHOLD	0-16	Adjust the trigger level of the drum.
-----------	------	---------------------------------------

As shown on the right, the B waveform will sound and the A and C waveforms will not occur.

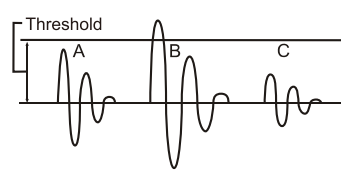

Note: If the value you set is too high, a light blow will not sound.

SCANTIME	02-08	Adjust the detection time of the trigger signal.
----------	-------	--

When setting, try a soft and powerful blow and confirm the natural change in volume.

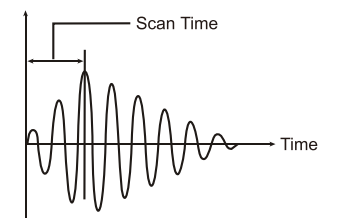

Note: If the value you set is too high, the sounding time will be lengthened. Please set as low as possible.

MASKTIME	16-64	Adjust the masking time of the trigger signal.
----------	-------	--

Note: When playing fast, too high values may mask the trigger signal, so lower the value as much as possible.

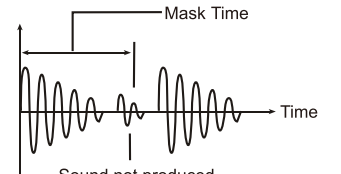

Parameter	Adjustment range	Parameter description
XTALK CANCEL	00-80	Adjust the crosstalk value.

When hit, some drums that are not hit are also triggered to sound, improving the XTALK CANCEL of the drum that is being audible.

Note: If the value is set too high and the strike is at the same time, the drum with a small striking force may not be triggered. Therefore, the value is set as small as possible without crosstalk.

CURVE	00-03	
-------	-------	---

RIM GAIN	01-99	Adjust the edge hit gain to be effective only for the drum rim and the cymbals edge.
----------	-------	--

HEAD RIM ADJUST	00-99	When you hit the rim or the side, the tone will be worse than you want, you can improve this by adjusting RIM ADJUST. If the value is set too low, you will not be able to play it.
-----------------	-------	---

In the adjustment process, SENS adjustment and RIMG adjustment are used the most. When you need to adjust the sensitivity of the drum head, you can adjust it through SENS. When you need to adjust the rim sensitivity, adjust it through RIMG. Cymbal bow and edge adjustment are also applicable to SENS and RIMG

Abbreviation and full name comparison table

ABBREVIATION	FULL NAME
SENS	SENSITIVITY
THRE	THRESHOLD
SCAN	SCANTIME
MASK	MASKTIME
XTLK	XTALK CANCEL
CRVE	CURVE
RIMG	RIM GAIN
RIMA	HEAD RIM ADJUST

FUNCTION OPERATION

Reverb function

1. Press REVERB to enter the reverb function interface.

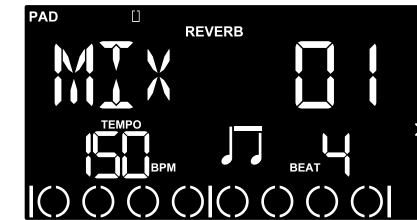

2. Use -+ button to adjust the mix.
3. Press the REVERB button again to turn off the reverb.

DEMO Song

1. Press the SONG button to enter the DEMO song function interface.
2. Press -+ key to select a track, press PLAY/STOP keyboard to play or pause the music. Press the DRUM OFF button to mute the demo song drum sound.

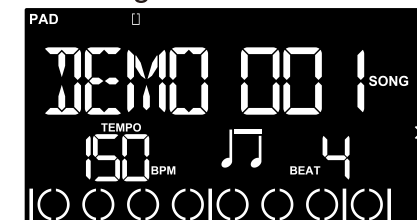

3. In SONG mode, press the MENU button to enter the SONG setting interface.
4. In the SONG setting interface, press OK to switch the parameter you want to adjust, and press -+ to adjust the parameter value.



Metronome

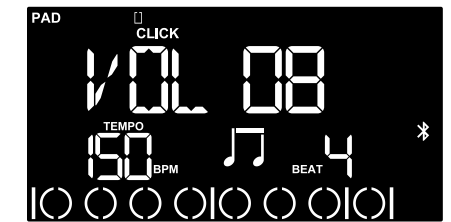

1. Press the CLICK button to enter the metronome function and turn on the metronome also.
2. In metronome interface, press OK switch button to switch the parameter you want to adjust.
3. Use -+ button to adjust the parameter value. The parameter value range as below.
TEMPO:40-280bpm
Rhythm: Quarter note, Eighth note, Triplet, 16th note
Beat:1-9
Volume:1-9
4. Press the CLICK to turn off the metronome.

Recording

1. Press the REC button to enter the recording mode, that is ready to record. Press REC in the ready state to exit the recording.

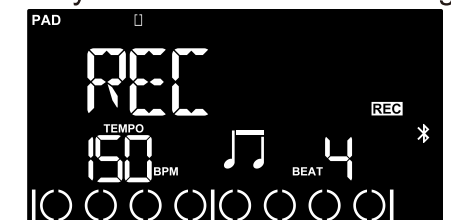

2. In the ready state, hit any drum to start recording.

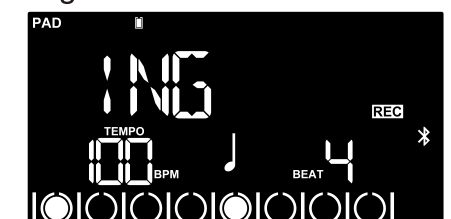

3. During the recording process, press the REC button or stop playing for five seconds, the recording ends.

FUNCTION OPERATION

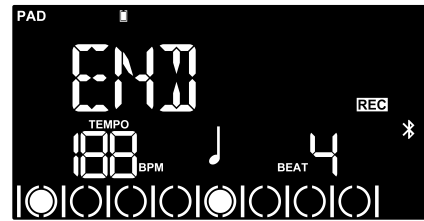

4. In the END state, press the PLAY button to play the recording, and press the REC button to enter the state of preparing for recording again.

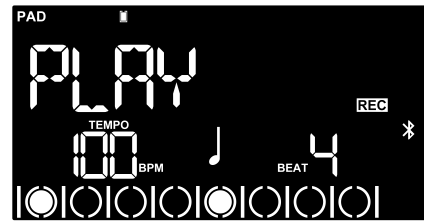

Coach

Press the COACH key to enter the coach function, press -+ keys to switch the type, press the OK key to enter.

TIME	TIME CHECK
C-UP	CHANGE UP
Q-CO	QUIET COUNT
S-CO	STROKE COUNT

* TIME CHECK

1. In the TIME 0 interface, press OK to enter the TIME CHECK preparation mode, the screen display changes to TIME 1.

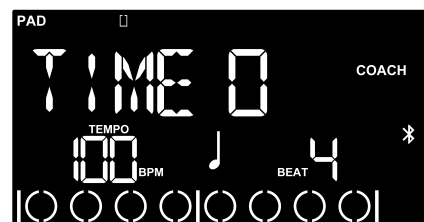

2. In the TIME 1 interface, press the CLICK button, and the practice will begin after one measure of preparation. During the exercise,

, the interface display changes to TIME 3. (If scoring is turned on in the settings, the score will appear after the practice is over).



3. In the TIME 1 interface, click MENU to enter the time check setting, and use the ok key to switch the parameters to be adjusted. The selected item flashes, use -+ to adjust the parameter value (SCOR=open/close scoring, TIME=practice time, BPM=practice speed).

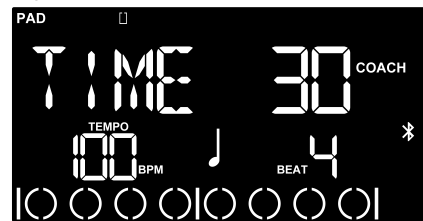

* CHANGE UP

1. In C-UP 0 mode, click ok to enter the change up preparation mode, the screen display changes to C-UP 1.



FUNCTION OPERATION

2. In C-UP 1 mode, click CLICK, after one measure of pre-beat, the practice starts. Interface display during practice becomes C-UP 3.

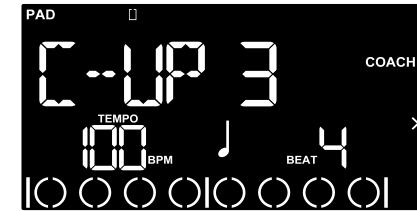

3. In the C-UP 1 interface, press MENU to enter the CHANGE UP setting, use the ok key to switch the parameter to be adjusted, the selected item flashes, and use -+ to adjust the parameter value. (BAR=Bar=Rhythm change after X bar, BPM=Practicing speed)

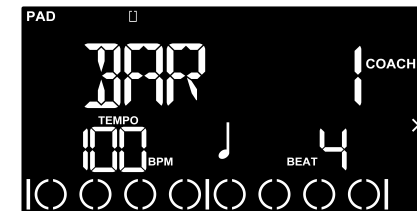

* QUIET COUNT

1. In the Q-CO 0 interface, click OK to enter the quiet count practice preparation mode, the screen display changes to Q-CO 1.



2. In Q-CO 1 mode, click CLICK, after one measure of pre-beat, the practice starts. Interface display during practice become Q-CO 3.



3. In the interface of Q-CO 1, press MENU to enter the QUIET COUNT setting, use the ok key to switch the parameter to be adjusted, the selected item flashes, and use -+ to adjust the parameter value. (BAR=bar=silent bar, BPM=practice speed)

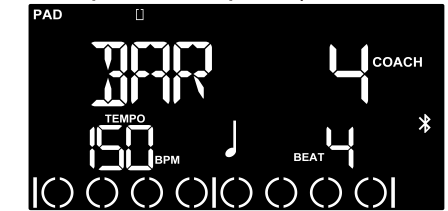

* STROKE COUNT

1. This mode is used to calculate the drummer's speed in a fixed time.
2. In S-CO mode, press OK to enter the STROKE COUNT practice preparation mode, the screen display changes to PREP 1.

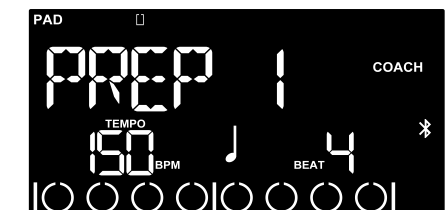
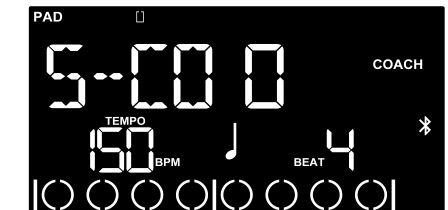

3. In the PREP 1 interface, hit the drums directly, the counting practice starts, after the practice is over, press CLICK to return to PREP 1 state.



4. In the PREP 1 interface, click MENU to enter the stroke count setting interface, and adjust the parameter value through -+ to run the system (TIME=counting duration).

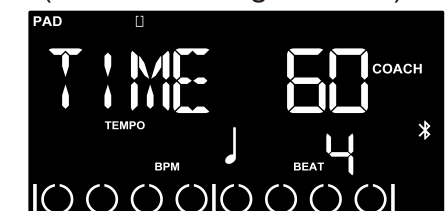

FUNCTION OPERATION

System settings

* RESET(RSET)

1. In DRUM mode, press MENU to enter the setting. Press -+ key to select RESET, press OK key to enter, after entering, it will display RSET ALL, press OK key again, the screen will directly return to the main interface, and the factory reset is complete.

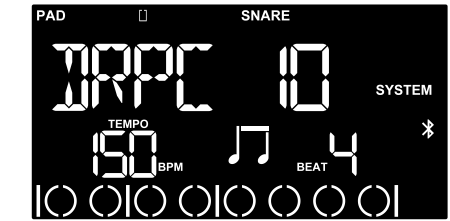
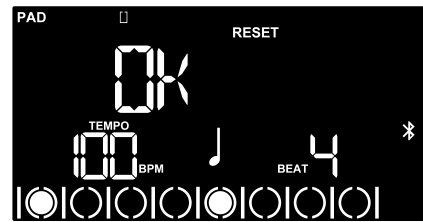
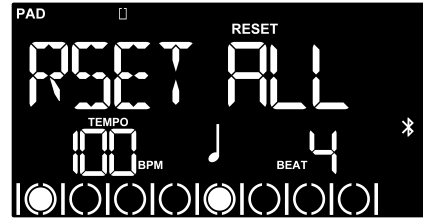

DRPC= MIDI OUTPUT CHANNEL

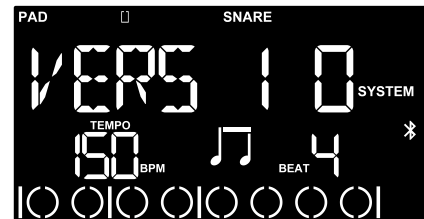

VERS=VERSION

* AUX IN Recording

1. Connect the mobile phone/ipad to the DM-210 host through the AUX IN interface.
2. Open the recording APP on the mobile phone/Ipad, click the recording button on the mobile phone and start playing, the content of the performance will be recorded into the mobile phone/ipad.

*When you need to use this function, please use 1/8" TRRS cable.

*BLUETOOTH

Connect DM-200SERIES with Bluetooth

1. Turn on the phone's Bluetooth.
2. Find DM-200SERIES under Bluetooth device and connect.
3. After the connection is successful, you can use your phone to play music on DM-210.

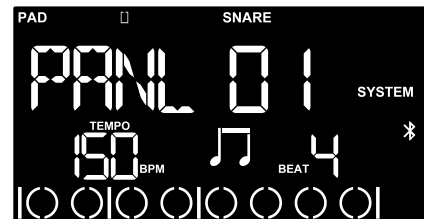

PANL= PAN LEFT

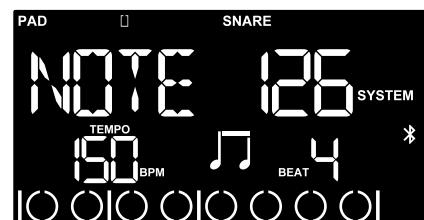

NOTE= MIDI NOTE

MIDI EXECUTION LIST

Function	Transmitted	Recognized	Remarked	
Basic default	10	10		
Channel changed	No	No		
Note	0-127	0-127		
Velocity:	Note on	Yes	Yes	
	Note off	No	Yes	
After Key's	No	No		
Touch Channel's	No	No		
Control change:	0	No	No	Bank select
	1	No	No	Modulation
	5	No	No	Portamento time
	7	No	No	Volume
	10	No	No	Pan
	11	No	No	Expression
	64	No	No	Sustain pedal
	65	No	No	Portamento on/off
	66	No	No	Sostenuto pedal
	67	No	No	Soft pedal
	120	No	No	All sound off
121	No	No	Reset all controllers	
123	No	No	All note off	
Program change	No	No		
System exclusive	No	No		

DRUM KIT'S NAME

01	STAD = STANDARD	09	METL = METAL
02	ORIG = ORIGINAL	10	ELEC= ELECTRIC
03	ROCK = ROCK	11	DANC=DANCE
04	STUD = STUDIO	12	TECH=TECHNOLOGY
05	FUNK = FUNK	13	PERC=PERCUSSION
06	HYBD = HYBIRD	14	SESS=SESSION
07	BLUE = BLUES	15	CHN = CHINA
08	JAZZ = JAZZ		

SPECIFICATION

Display:	Negative display segment code LCD
Drum set:	15 presets
DEMO song:	10
Recording:	1
CLICK:	speed, rhythm, beat, volume
MIDI:	USB MIDI, automatic computer recognition
Effects:	Reverb
Trigger:	3TOM, 1SNARE, 1HIHAT, 1CRASH, 1RIDE, 1KICK
Interface:	POWER, OUTPUT, AUX IN, USB, CYMBAL TRIGGER, PHONE
Power:	DC 9V external positive and internal negative, working current 200mA

*Technical specifications are subject to change without notice.

This device complies with part 15 of the FCC Rules. Operation is subject to the following two conditions: (1) this device may not cause harmful interference, and (2) this device must accept any interference received, including interference that may cause undesired operation. Any changes or modifications not expressly approved by the party responsible for compliance could void the user's authority to operate the equipment.

NOTE: This equipment has been tested and found to comply with the limits for a Class B digital device, pursuant to Part 15 of the FCC Rules. These limits are designed to provide reasonable protection against harmful interference in a residential installation. This equipment generates, uses and can radiate radio frequency energy and, if not installed and used in accordance with the instructions, may cause harmful interference to radio communications. However, there is no guarantee that interference will not occur in a particular installation. If this equipment does cause harmful interference to radio or television reception, which can be determined by turning the equipment off and on, the user is encouraged to try to correct the interference by one or more of the following measures:

- Reorient or relocate the receiving antenna.
- Increase the separation between the equipment and receiver.
- Connect the equipment into an outlet on a circuit different from that to which the receiver is connected.
- Consult the dealer or an experienced radio/TV technician for help. To maintain compliance with FCC's RF Exposure guidelines, This equipment should be installed and operated with minimum distance between 20cm the radiator your body.

According to the technical specifications of low-power radio frequency equipment:

For low-power radio frequency equipment that has been certified, companies, firms, or users are not allowed to change the frequency, increase the power, or change the characteristics and functions of the original design without approval. The use of low-power radio frequency equipment must not affect flight safety and interfere with legal communications; if interference is found, it should be stopped immediately and improved to no interference before continuing to use. The aforementioned legal communication refers to radio communication operated in accordance with the provisions of the Telecommunications Administration Law. Low-power radio frequency equipment must endure the interference of legal communications or industrial, scientific and medical radio wave radiation electrical equipment.

© Cherub Technology Co., Ltd.

All Rights Reserved. No part of this publication may be reproduced, stored in a retrieval system, or transmitted, in any form or by any means, electronic, mechanical, photocopying, recording, or otherwise, without the prior written permission of Cherub Technology Co., Ltd.

Environment temperature 0-40 degree.



Made in China

安全使用本乐器

为避免火灾、电击以及人身伤害，请遵循以下指示：

- 将本乐器的AC适配器插头与带有接地保护的电源插座连接。
- 请勿自行拆解或改动本乐器的任何部件，以免因操作不当而导致损坏。
- 请勿尝试自行修理或更换本乐器零件（除非说明书提供有安装选购配备的指示），如有任何关于本乐器的问题请就近咨询NUX服务中心或NUX授权经销商。
- 请勿将本乐器放置在以下场所：
 - 温度过高的场所（例如阳光直射下的封闭车辆中、热输送管附近或发热机器上方）。
 - 潮湿处（例如浴室、洗手间或潮湿的地面）。
 - 直接遭雨淋的地方。
 - 灰尘多的地方。
 - 有强烈震动的地方。
- 请将本乐器放置于平坦之处，以确保其稳固。请勿将本乐器放置于可能会摇晃的支架上或倾斜之处。
- 本乐器必须连接操作说明书中所指示的AC适配器，并且请勿将此AC适配器用于其它设备。
- 请勿过度扭曲或弯折AC适配器上的电源线，也不可以在此上面放置重物。这样可能会因损坏电源线而造成元件短路，重则可能造成火灾和触电的危险！
- 无论单独使用本乐器或者连接使用放大器、音箱或耳机时，过大的音量可能会导致听力永久损害。请勿长期在过大音量或者会导致不适的音量下使用。如果您感到任何听力损失或产生耳鸣，请停止使用并及时就诊。
- 请勿将任何物品（如易燃物、硬币、别针等）或任何液体，掉入或渗入本乐器中。
- 当发生以下情况时：
 - AC适配器、电源线或插头破损。
 - 任何部件冒烟或者发出异味。
 - 异物或液体不慎掉入或渗入本乐器。
 - 本乐器直接遭雨淋（或打湿）。
 - 本乐器音源主机显示异常（如出现乱码或黑屏等）。请立刻关闭音源主机电源，拔掉AC适配器插头，并与当地NUX服务中心或NUX授权经销商联系。
- 请注意家中的孩童。成人应监督孩童行为，直到他有能力遵循安全指示操作本乐器。
- 避免强烈的碰撞本乐器。（请勿摔落！）
- 请勿将过多的电器与本乐器共用一个插座。在使用延长电缆线时，请特别注意您连接在延长电缆线上的所有设备，其总功率绝不能超过延长电缆线所能承受的功率。电流的超载会导致电缆线发热并溶解包覆电缆线上的绝缘物质。
- 在国外使用本乐器之前，请与当地NUX服务中心或NUX授权经销商联系。
- 请勿将盛有水的容器（包括但不限于花瓶、杀虫剂、香水、酒精、指甲油或喷雾剂等）或饮料放置于本乐器上。擦拭本乐器时请使用柔软的干布。
- 请将本乐器放置在不影响其良好通风的场所或方向。
- 将AC适配器的插头插入或者拔离插座时，请手拿AC适配器的插头部分，并保证手部干爽。
- 每隔一段时间，您必须将AC适配器的插头从插座上拔掉，并用干布擦拭和清除累积在插

头上的灰尘。当长期不使用本乐器时，也请将AC适配器的插头拔离插座。在AC适配器的插头与插座之间沉积的灰尘可能会使绝缘不良从而导致火灾。

- 请避免各种线材之间互相缠绕（如AC适配器电源线、音频导线、其它外部连接线等）。此外，请让孩童远离所有线材，以免造成危险。
- 请勿踩踏或在本乐器上放置重物。
- 手部潮湿时，请勿使用本乐器（包括拔插电源设备）。
- 移动本乐器之前，请将AC适配器从音源主机上拔离，并且将与外部设备正连接的音频导线拔离音源主机。
- 清洁本乐器之前，请关闭音源主机电源，并将AC适配器插头从插座上拔离。
- 若怀疑您所在地区可能发生雷击时，请将AC适配器插头拔离插座。
- 请将螺丝等细小零部件放置于孩童触及不到的安全之处，以免孩童误吞食。

根據低功率射頻器材技術規範：
取得審驗證明之低功率射頻器材，非經核准，公司、商號或使用者均不得擅自變更頻率、加大功率或變更原設計之特性及功能。低功率射頻器材之使用不得影響飛航安全及干擾合法通信；經發現有干擾現象時，應立即停用，並改善至無干擾現象時方得繼續使用。前述合法通信，指依電信管理法規定作業之無線電通信。低功率射頻器材須忍受合法通信或工業、科學及醫療用電波輻射性電機設備之干擾。

组装示意图.....	04
各部件名称.....	07
音源控制面板.....	08
连接音频设备.....	09
显示屏幕.....	10
准备演奏.....	11
功能操作.....	14
套鼓整体切换.....	14
套鼓鼓盘设置.....	14
混响功能操作.....	16
DEMO曲功能操作.....	16
节拍器功能操作.....	16
录音模式操作.....	16
教练功能操作.....	17
系统功能设置.....	19
MIDI执行列表.....	20
鼓组名称.....	20
技术规格.....	21

各部件组装

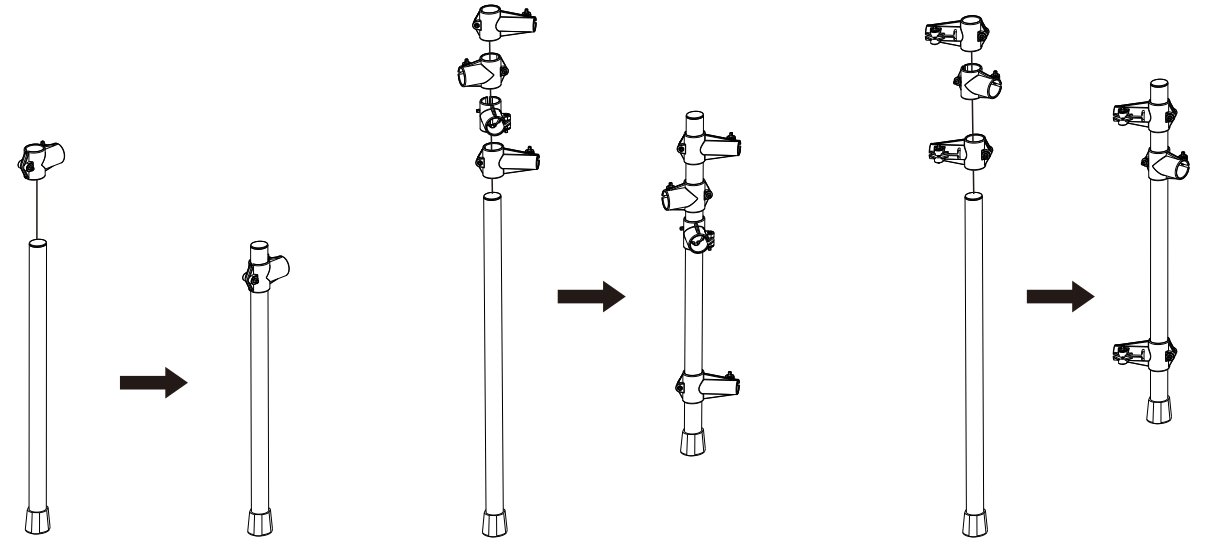

鼓架前支架 (2PCS)

鼓架后支架 (左)

鼓架后支架 (右)

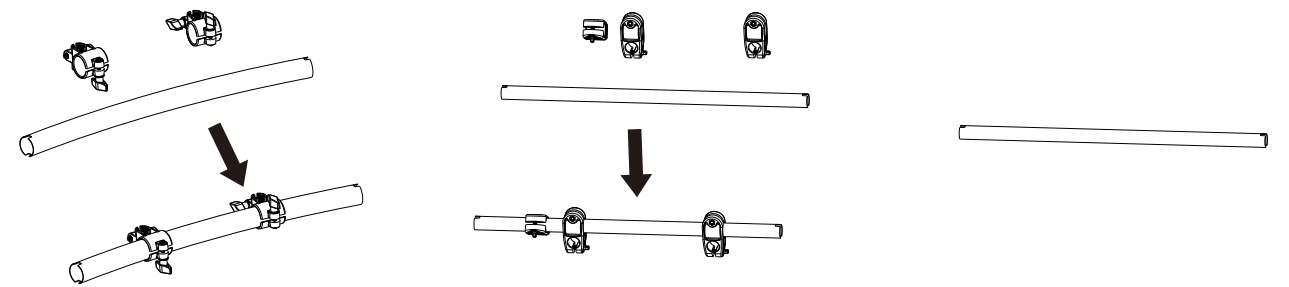

鼓架侧臂 (2PCS)

鼓架上横梁(1PCS)

鼓架下横梁(1PCS)

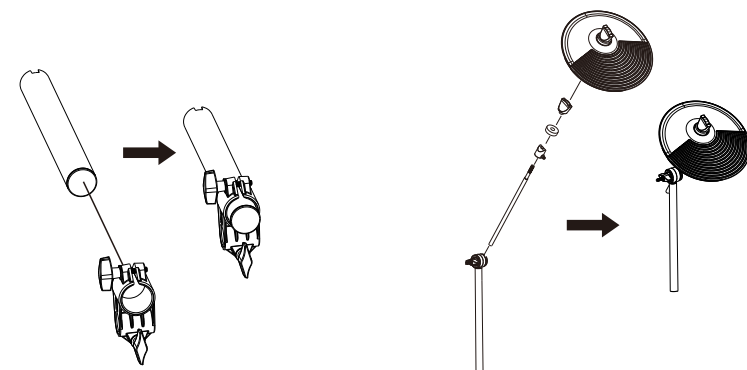

军鼓支撑架(1PCS)

镲片(2PCS)

总装示意图

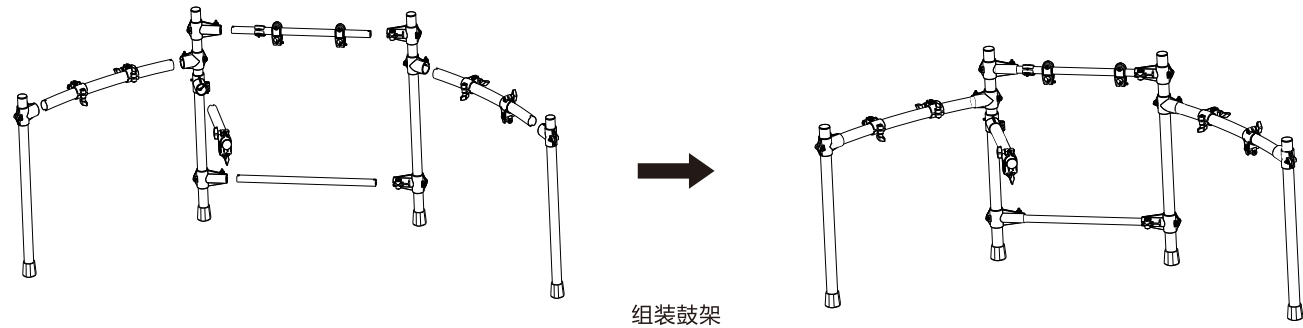

组装鼓架

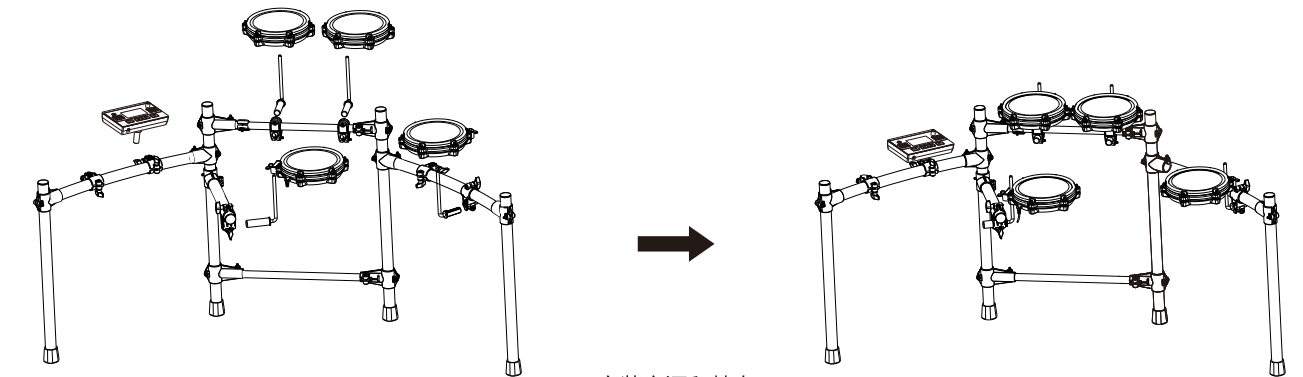

安装音源和鼓盘

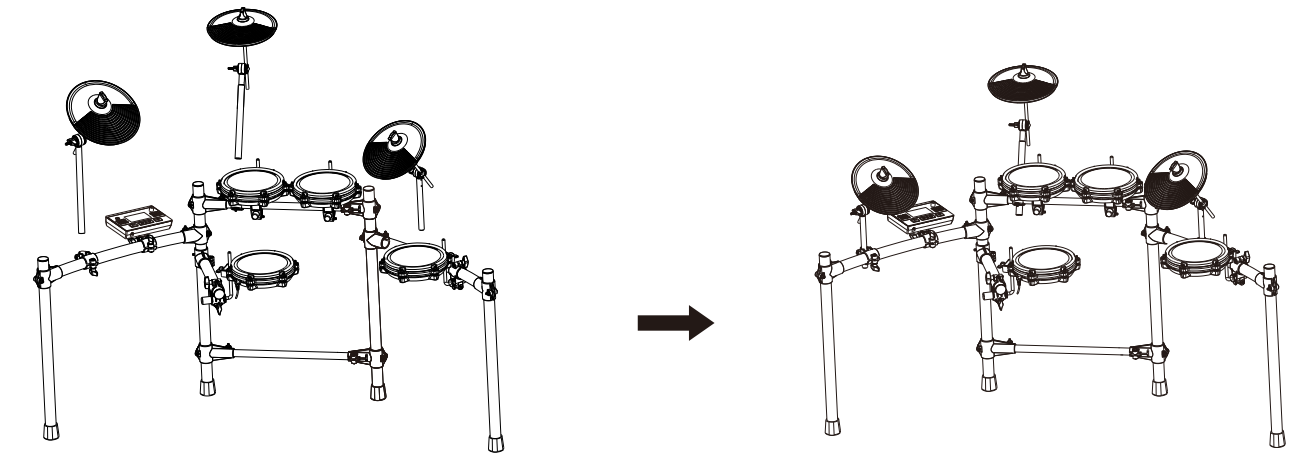

安装镲片

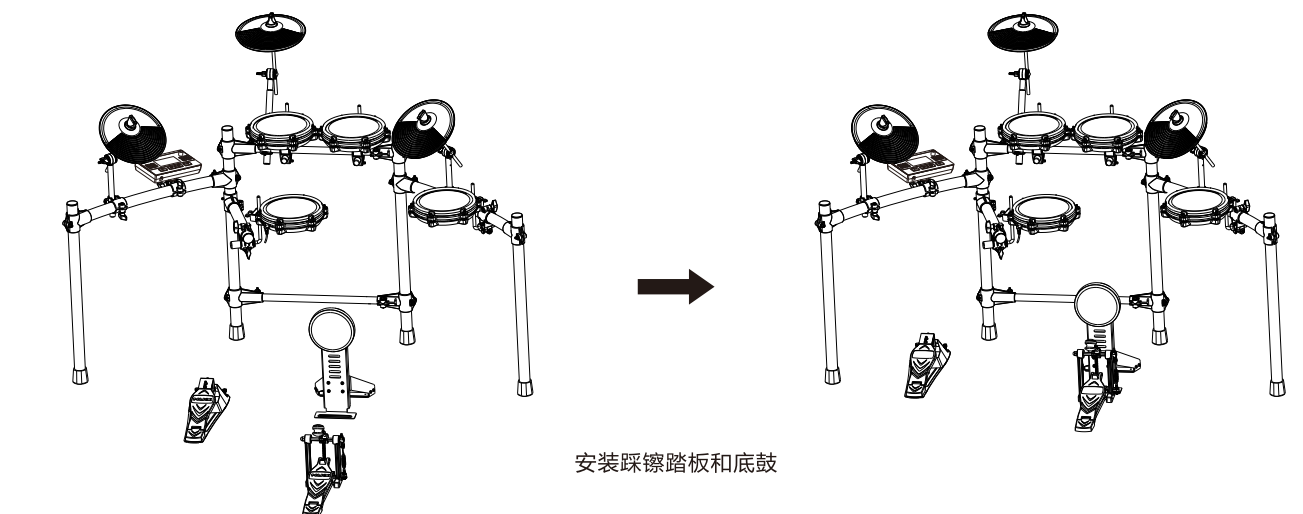

安装踩镲踏板和底鼓

连接数据线

1. 连接数据线到音源系统。

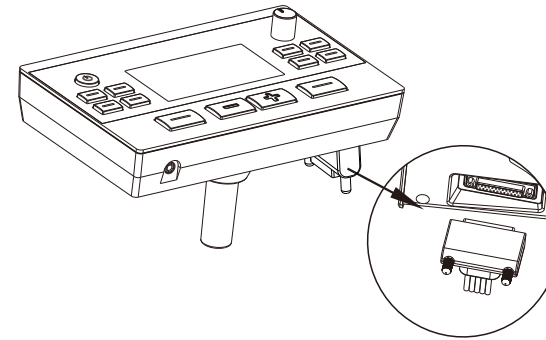

3. 连接踩镲踏板和底鼓踏板。

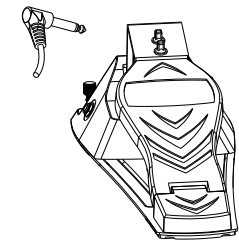

连接踏板

2. 连接鼓盘和镲片。

连接线上的标签指示所连接的打击垫或踏板的名称。

如下图所示：

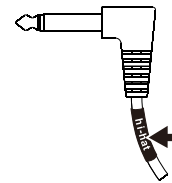

连接鼓盘：

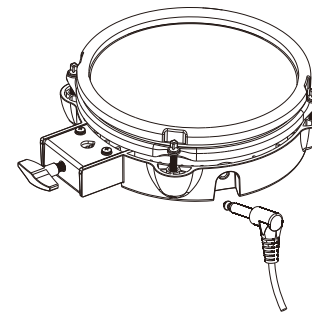

连接镲片：

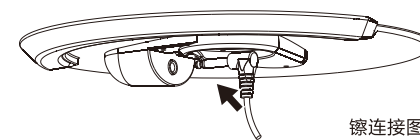

镲连接图

注意：为了防止设备故障或损坏，在连接设备时，请调低音量并把设备电源关闭。

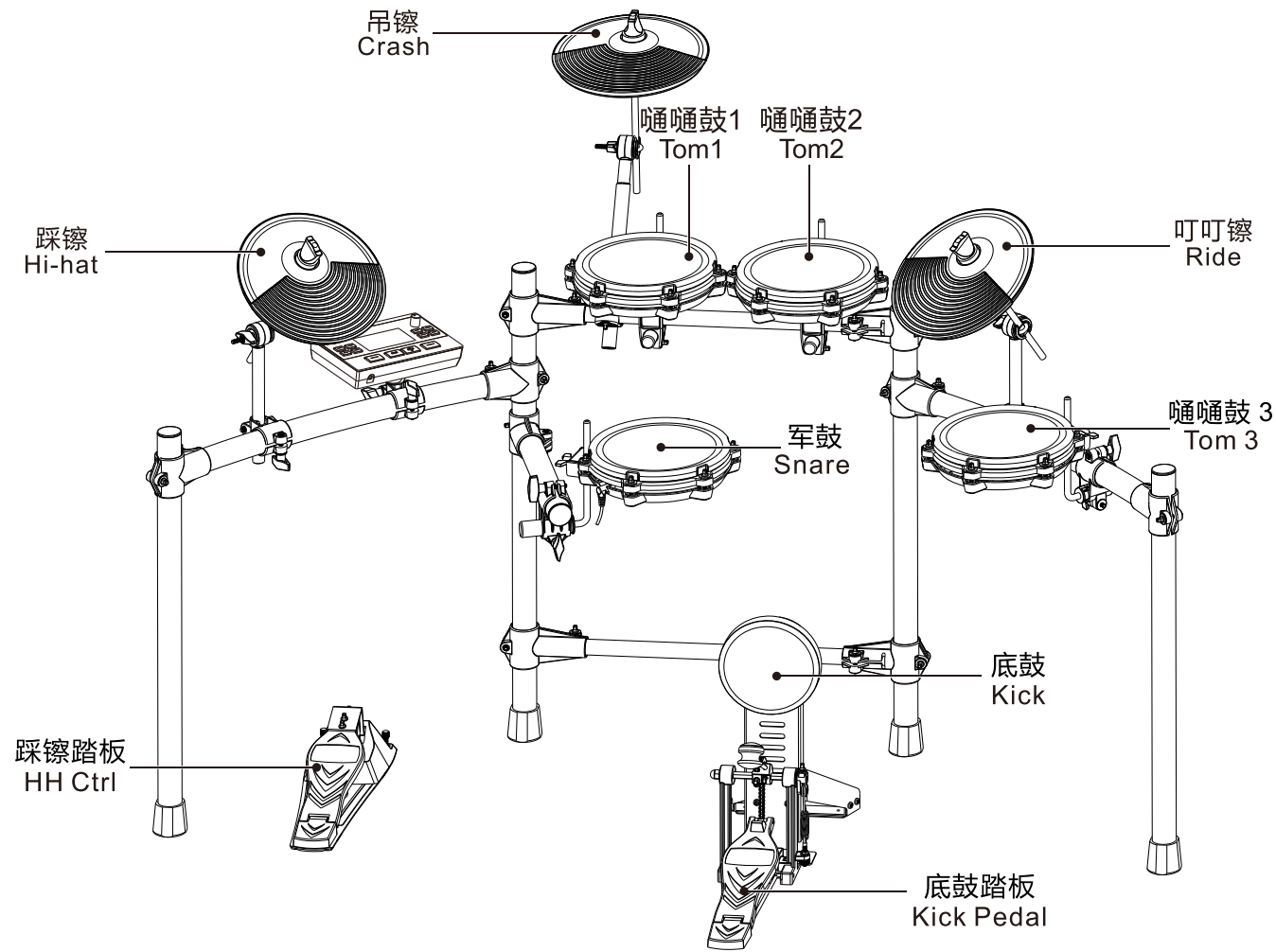

- 1. 显示屏
- 2. DM-210 开关按键
- 3. 节拍器开/关按键
- 4. 鼓组选择按键
- 5. 混响功能开/关按键
- 6. 教练功能开/关按键
- 7. 参数选择与调节按键
- 8. 菜单按键

- 9. 音量调节旋钮
- 10. 录音按键
- 11. 播放与暂停按键
- 12. 开启/关闭 DEMO 曲鼓声
- 13. DEMO 曲界面按键
- 14. 参数选择与调节按键
- 15. 确认按键
- 16. 耳机接口

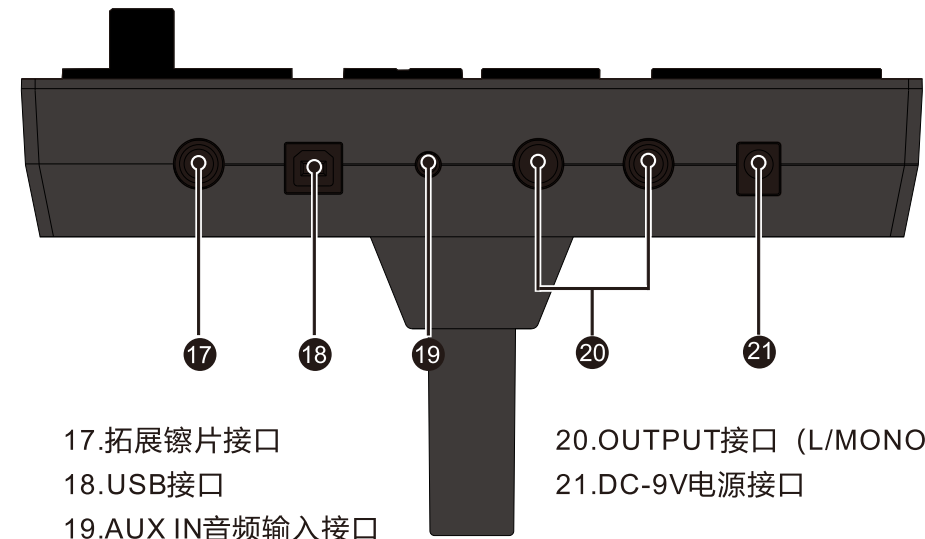

- 17. 拓展镲片接口
- 18. USB 接口
- 19. AUX IN 音频输入接口

- 20. OUTPUT 接口 (L/MONO 和 R)
- 21. DC-9V 电源接口

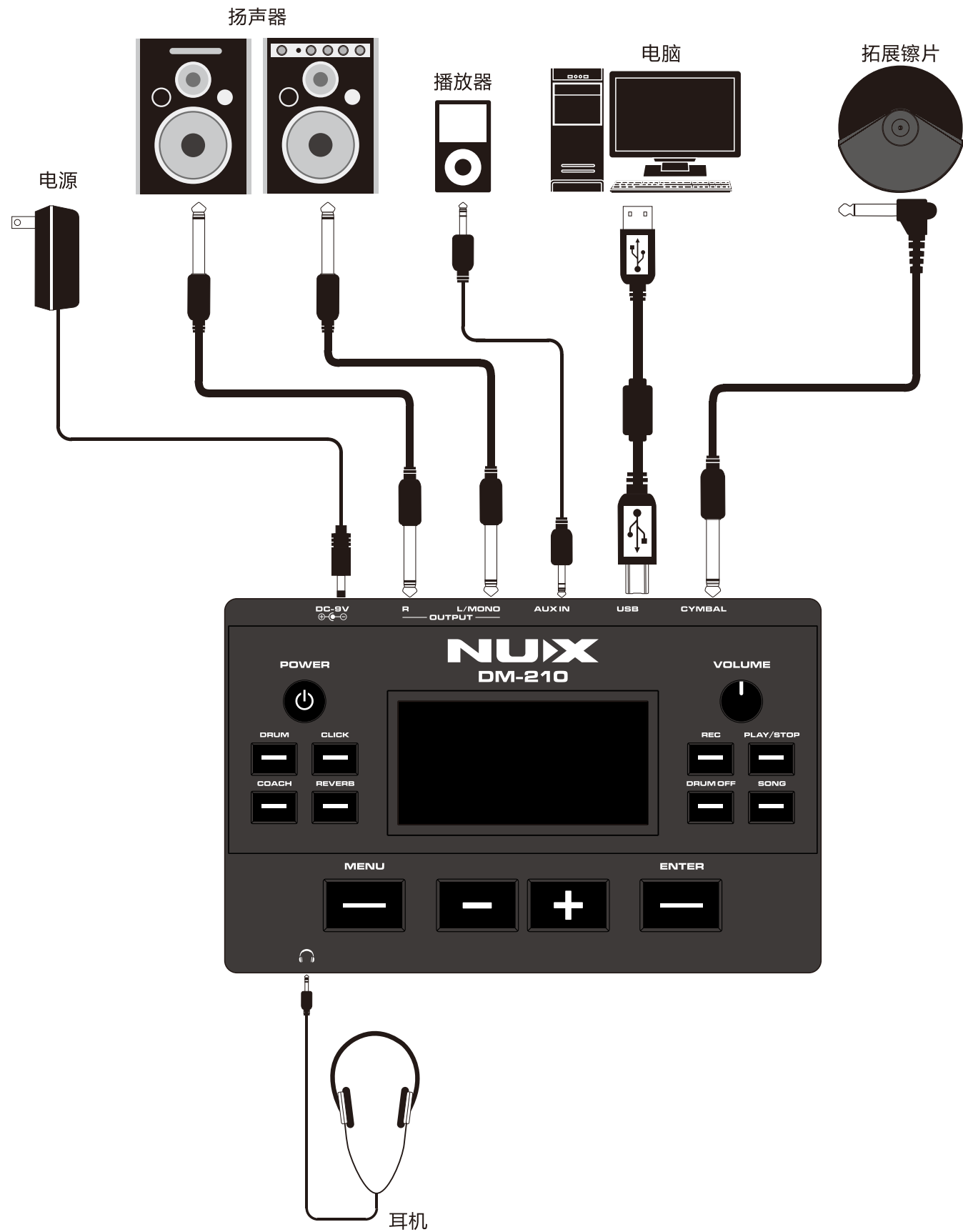

注意：

为了防止本乐器故障或损坏，在开机或进行其它设备连接前，请调低音量并把设备电源关闭。

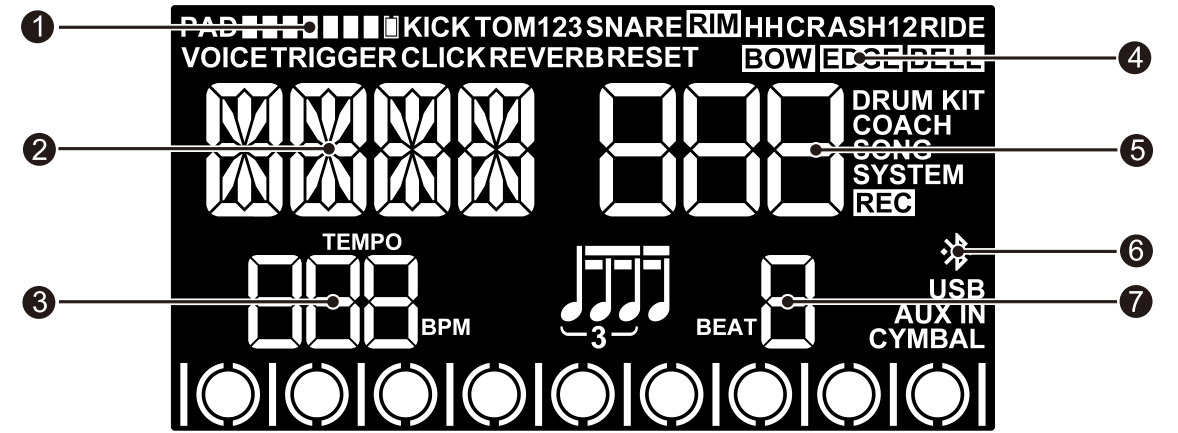

- 1. 力度显示
- 2. 参数名称显示
- 3. 节拍器速度显示
- 4. 部件显示
- 5. 参数值显示
- 6. 蓝牙显示
- 7. 节拍显示

*开启电源

1. 将VOLUME旋钮调节至最小。
2. 将外扩设备音量调节至最小。
3. 打开电源。



注：打开电源时，可能会听到微弱的声响，这是正常现象，并非故障。

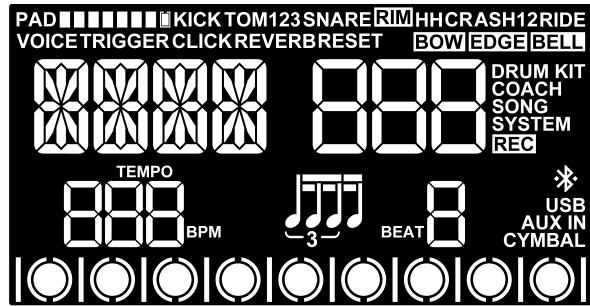

4. 敲击鼓盘、镲片，调节音量。
按照你的需要提高外扩设备的音量。

*关闭电源

1. 将DM-210外扩设备的音量调节至最小。
2. 关闭外扩设备的电源。
3. 关闭DM-210电源。



*军鼓 (Snare)

面击
打击鼓面

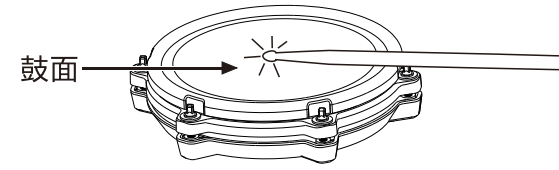

边击
打击鼓边

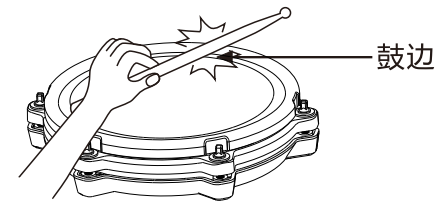

*嗵鼓 (Tom)

面击
打击鼓面

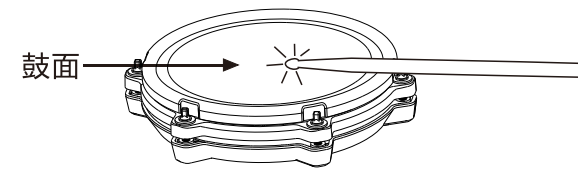

边击
打击鼓边

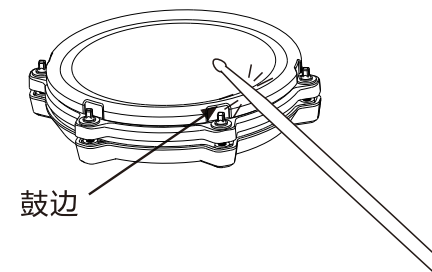

*底鼓 (Kick)

打击 踩下底鼓踏板

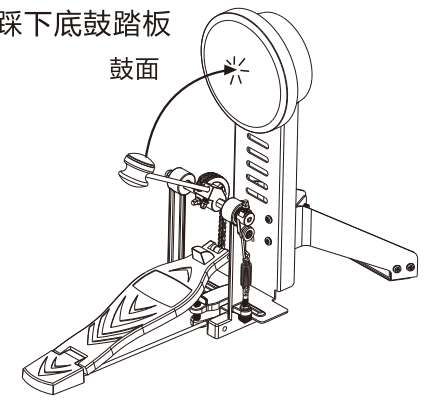

*镲片 (Crash Ride)

面击
打击镲片的面

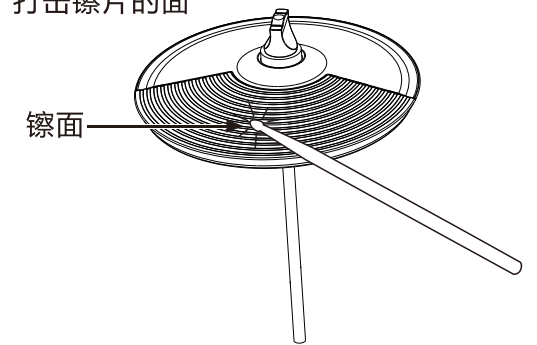

边击
打击镲片的边缘

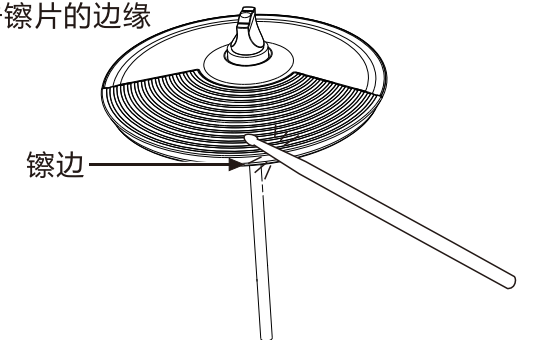

镲片静音

打击镲片后，立即用手捏住镲片的边缘将会进行静音。如图所示捏住边缘触发器的位置。如果您捏住其它无触发器的位置，镲片将不会静音。

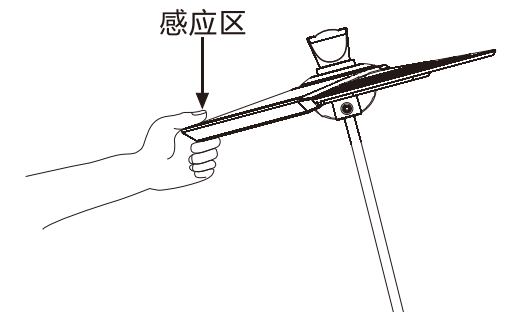

* 踩镲 (Hi-hat)

开放/闭合

踩镲音色将在开放和闭合之间改变，这将取决于踩镲踏板和踩镲镲片的力度控制。

面击

打击镲片的面

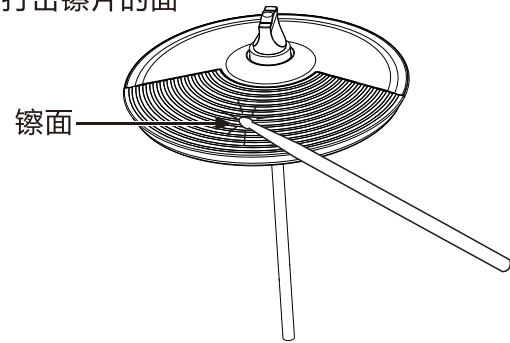

镲片静音

打击镲片后，立即用手捏住镲片的边缘将会进行静音。如图所示捏住边缘触发器的位置。如果您捏住其它无触发器的位置，镲片将不会静音。

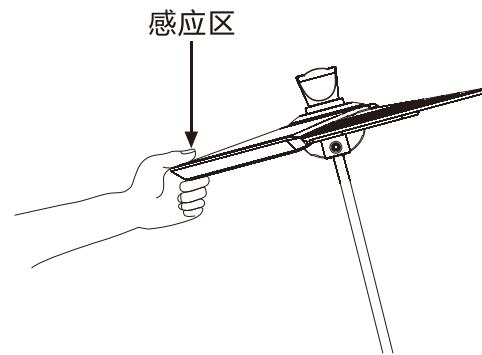

* 踩镲控制踏板 (HH Ctrl)

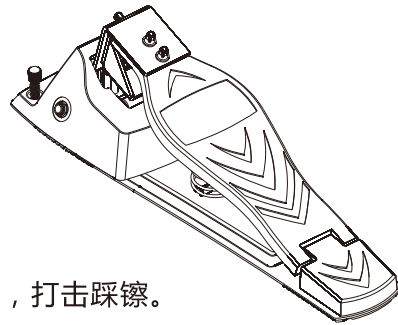

开放踩镲

不踏下踏板，打击踩镲。

闭合踩镲

踏下踏板，打击踩镲。

套鼓整体切换

* 开机即进入Drumkit模式

1. 使用-+按键选择鼓组。
2. 在其它模式下，按DRUM按键，可回到鼓组切换界面。

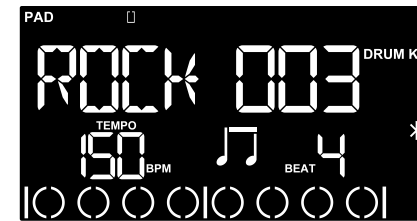

套鼓鼓盘设置

1. 在DRUM模式下，按MENU按键进入菜单。
2. 通过-+按键选择VOICE 或TRIG(trigger)调节鼓盘参数，按OK按键确认，按MENU按键返回主菜单。

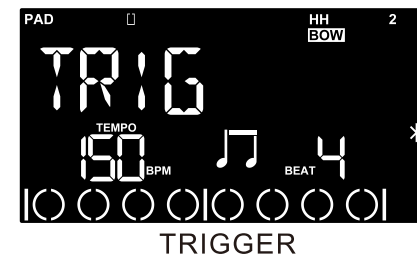
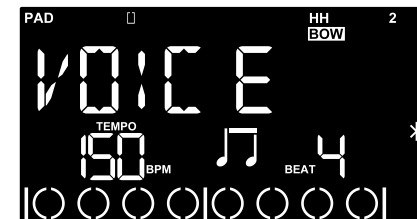

* VOICE菜单

1. 在VOICE界面，敲击任意鼓盘选择你要调节的鼓盘。
2. 按OK按键选择你所需要调整的参数。



PITCH

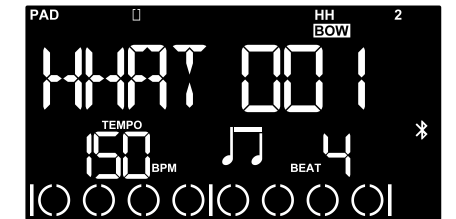

音色切换



VOLUME

3. 通过-+按键调节参数值，调节完毕可按MENU按键返回，设置结果直接保存。

* TRIG (Trigger) 菜单

1. 在TRIG界面，敲击任意鼓盘选择你要调节的鼓盘。
2. 按OK按键选择你所需要调整的参数。
3. 通过-+按键调节参数值，调节完毕可按MENU按键返回，设置结果直接保存。

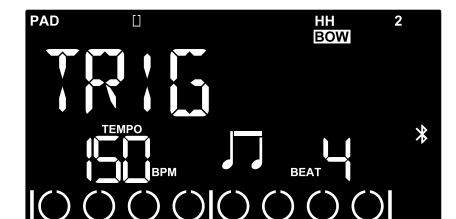

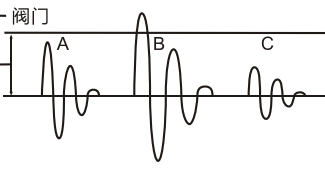
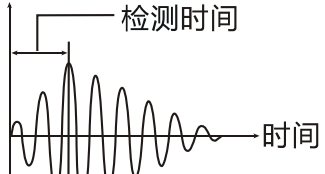
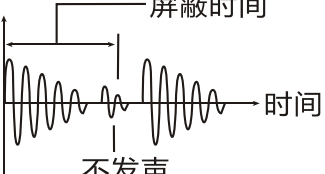
参数名称	调节范围	参数说明
SENSITIVITY	01-99	调节鼓盘灵敏度，灵敏度越高，打击垫即使轻轻敲打也会产生响亮声音。灵敏度越低，即使用力敲打也会产生小的音量。请多尝试并调节出适合自己打击习惯的灵敏度。
THRESHOLD	0-16	调节鼓盘的触发电平。
<p>如右图，B波形将会发声，而A和C波形将不会发生。 注：如果您设置的数值过高时，轻轻打击将不会发声。</p> 		
SCANTIME	02-08	调节触发信号的检测时间。
<p>设置时，请尝试柔和的与有力度的打击，并确认音量自然的改变。 注：如果您设置的数值过高，发声的时间将拉长。请尽可能的设置为较低的数值。</p> 		
MASKTME	16-64	调节触发信号的屏蔽时间。
<p>注：快速演奏时，过高的数值可能会屏蔽触发信号，故尽可能的调低数值。</p> 		

参数名称	调节范围	参数说明
XTALK CANCEL	00-80	调节交叉串扰值。 打击时，某些没被打击的鼓盘也被触发发声，提高被串扰发声的鼓盘的XTALK CANCEL。 注： 如果数值设置过高，同时打击时，可能会发生打击力度小的鼓盘不被触发。故在不发生串扰的情况下，数值尽可能的设置最小。
CURVE	00-03	
RIM GAIN	01-99	调节边击增益，只对鼓边和擦边有效。
HEAD RIM ADJUST	00-99	当您用力打击鼓边时，音色会不如您意时，您可以通过调节RIM ADJUST来改善这一问题。如果数值设置过低，您将不能进行边击演奏。

注：在调节过程中，使用最多的是SENS调节与RIMG调节，当您需要调节鼓盘鼓面灵敏度的时候，通过SENS进行调节。当您需要调节鼓边灵敏度的时候，通过RIMG调节。擦面与擦边调节同样也适用SENS与RIMG。

简写与全称对照表

简称	全称
SENS	SENSITIVITY
THRE	THRESHOLD
SCAN	SCANTIME
MASK	MASKTIME
XTLK	XTALK CANCEL
CRVE	CURVE
RIMG	RIM GAIN
RIMA	HEAD RIM ADJUST

混响功能操作

1. 按REVERB按键进入混响功能界面。

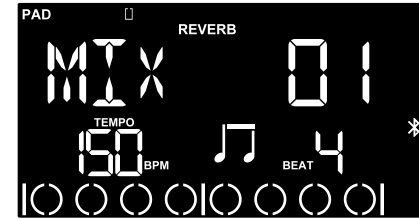

- 按-+按键调节混响深度。
- 再次按REVERB按键关闭混响。

DEMO曲功能操作

- 按SONG按键进入DEMO曲功能界面。
- 按-+按键选择曲目，按PLAY/STOP按键播放/暂停DEMO曲，按DRUM OFF按键，可静音DEMO曲内的鼓声。

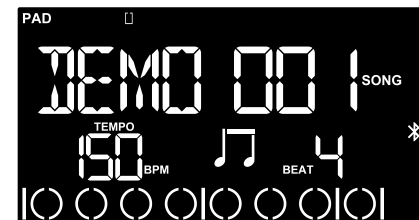

- 在SONG模式下，按MENU按键，进入SONG设置界面。
- 在SONG设置模式下，按OK按键切换所需调节的内容，按-+按键调节所选中的参数值。

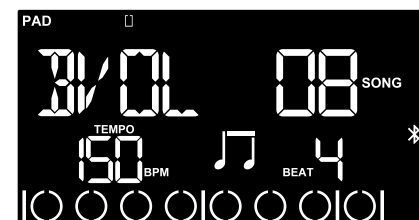

背景音乐音量

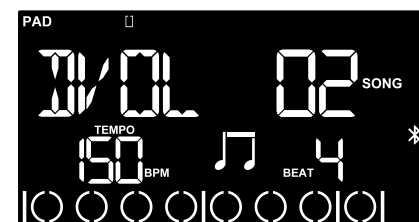

鼓音量

节拍器功能操作

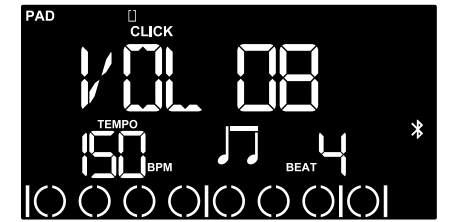

- 按CLICK按键，开启节拍器功能。
- 在节拍器界面下，按OK按键选择你要调整的参数。
- 按-+按键调节参数值，调节范围如下：
 速度：40-280
 节奏型：4分音符、8分音符、8分音符三连音、16分音符
 拍数：1-9
 节拍器音量：0-10
- 再次按CLICK按键关闭节拍器。

录音模式操作

- 按REC按键进入录音模式，即准备录音状态；在准备状态下按REC按键可退出录音。

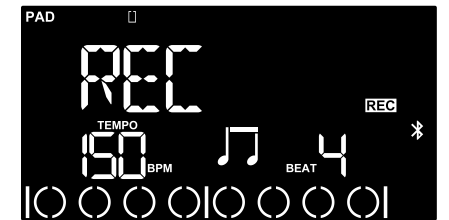

- 进入录音模式后，敲击任何部件录音开始。



- 录音过程中，按REC按键或停止演奏5秒后，录音结束。

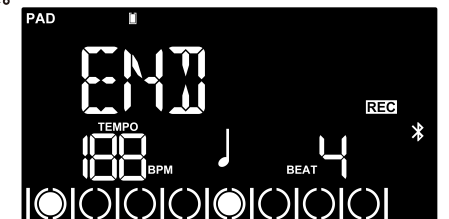

4. 在END状态下，按PLAY按键播放录音；按REC按键再次进入准备录音状态。

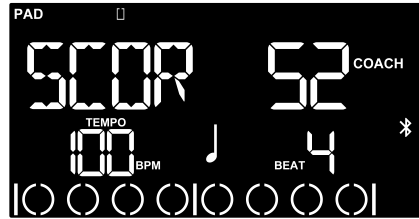
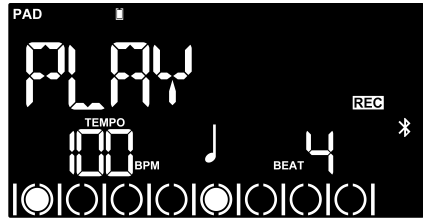

3. 在TIME 1界面中，按MENU按键进入TIME CHECK 设置，按OK按键切换需要调节的参数，选中项闪烁，按+按键调节参数值（SCOR=打开/关闭记分，TIME=练习时长，BPM=练习速度）。

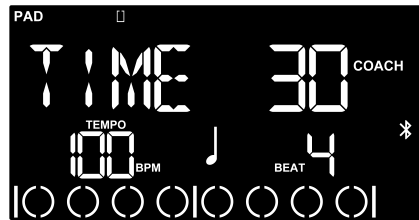

教练功能操作

按COACH按键进入教练功能，按-+按键切换教练功能类型，按OK按键进入相应功能界面。

TIME	TIME CHECK
C-UP	CHANGE UP
Q-CO	QUIET COUNT
S-CO	STROKE COUNT

* TIME CHECK

1. 在TIME 0界面下，按OK按键进入TIME CHECK 准备模式，屏幕显示变成TIME 1。

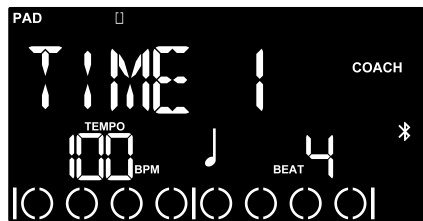
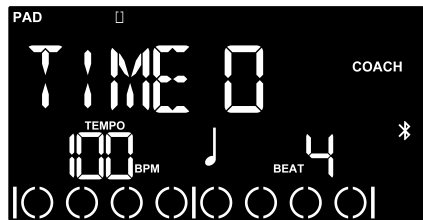

2. 在TIME 1界面下，按CLICK按键，一小节预备拍后，练习开始。练习过程中界面显示TIME 3。（若在设置中选择开启记分，则在练习结束后出现分数）

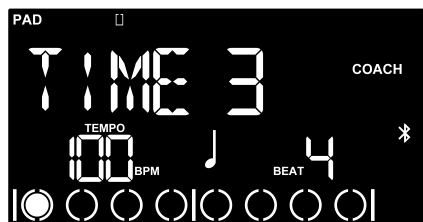

* CHANGE UP

1. 在C-UP 0模式下，按OK按键进入CHANGE UP 准备模式，屏幕显示变成C-UP 1。

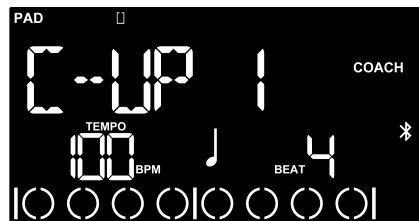

2. 在C-UP 1模式下，按CLICK按键，一小节预备拍后练习开始。练习过程中界面显示变成C-UP 3。



3. 在C-UP 1的界面下，按MENU按键进入CHANGE UP 界面设置，按OK按键切换需要调节的参数，选中项闪烁，按+按键调节参数值。（BAR=小节=X小节 后节奏型变化，BPM=练习速度）

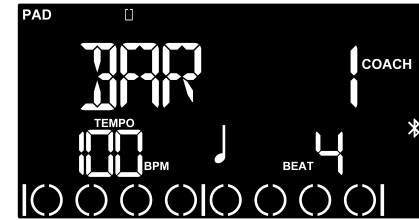

* QUIET COUNT

1. 在Q-CO 0界面下，按OK按键进入QUIET COUNT 练习准备模式，屏幕显示变为Q-CO 1。

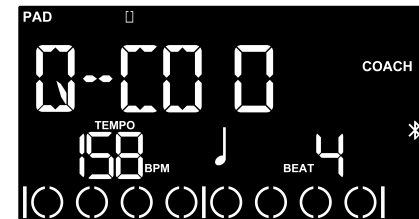

2. 在Q-CO 1模式下，按CLICK按键，一小节预备拍后练习开始。练习过程中界面显示变成Q-CO 3。

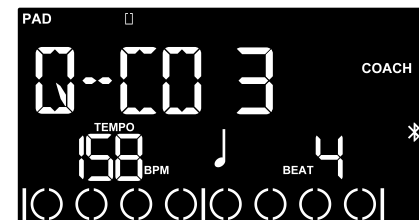

3. 在Q-CO 1的界面下，按MENU按键进入QUIET COUNT设置，按OK按键切换需要调节的参数，选中项闪烁，按+按键调节参数值。（BAR=小节=静音小节，BPM=练习速度）

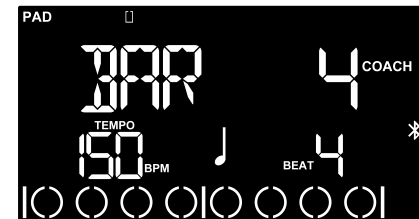

* STROKE COUNT

1. 此模式用于计算鼓手在固定时间内可以打出多少点数。

2. 在S-CO界面下，按OK按键进入STROKECOUNT 练习准备模式，屏幕显示变为PREP 1。

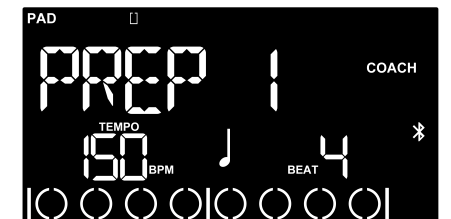
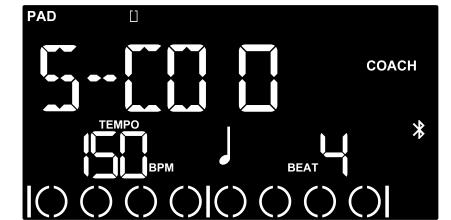

3. 在PREP 1界面下，直接敲击鼓盘，计数练习开始，练习结束后，按CLICK按键回到PREP 1状态。



4. 在PREP 1界面下，按MENU按键进入STROKE COUNT设置界面，按+按键调节参数值。（TIME =计数时长）

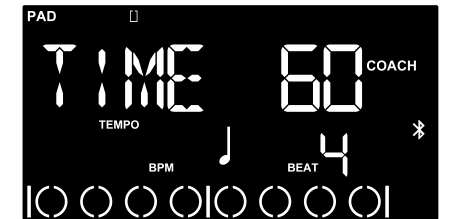

系统功能设置

* RESET (RSET)

在DRUM模式下，按MENU按键进入设置界面，按+按键选定RESET项目，按OK按键进入，进入后显示RSET ALL，再按一次OK按键，直接返回主界面，恢复出厂设置完成。

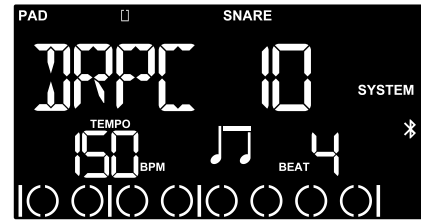
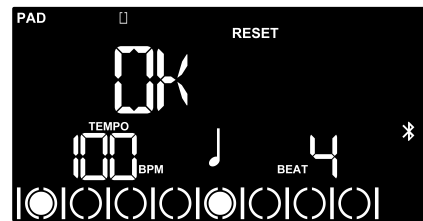
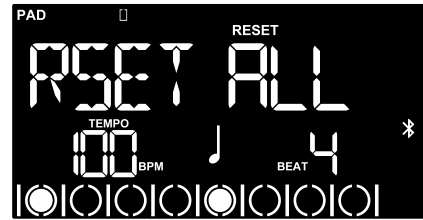

DRPC=midi输出通道



VERS=系统版本

* AUX IN 返录功能

1. 通过AUX IN接口连接手机/iPad 至DM-210主机。
2. 打开手机/iPad上自带录音APP，点击手机上的录音键后开始演奏，演奏的内容将会被录至手机/iPad中。

*需要使用返录功能时，请使用三环四段式的3.5mm音频连接线。

* 蓝牙功能

使用手机连接DM-200SERIES

1. 开启手机蓝牙功能。
2. 在蓝牙设备下找到DM-200SERIES，点击连接。
3. 连接成功后可以使用手机设备播放音乐。

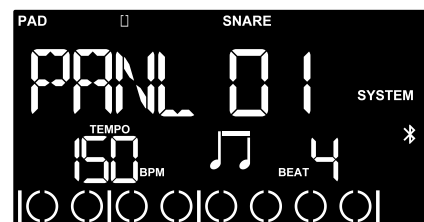

PANL=相位左



NOTE=midi值

Function	Transmitted	Recognized	Remarked	
Basic default	10	10		
Channel changed	No	No		
Note	0-127	0-127		
Velocity:	Note on	Yes	Yes	
	Note off	No	Yes	
After Key's	No	No		
Touch Channel's	No	No		
Control change:	0	No	No	Bank select
	1	No	No	Modulation
	5	No	No	Portamento time
	7	No	No	Volume
	10	No	No	Pan
	11	No	No	Expression
	64	No	No	Sustain pedal
	65	No	No	Portamento on/off
	66	No	No	Sostenuto pedal
	67	No	No	Soft pedal
120	No	No	All sound off	
121	No	No	Reset all controllers	
123	No	No	All note off	
Program change	No	No		
System exclusive	No	No		

鼓组名称

01	STAD = STANDARD	09	METL = METAL
02	ORIG = ORIGINAL	10	ELEC= ELECTRIC
03	ROCK = ROCK	11	DANC=DANCE
04	STUD = STUDIO	12	TECH=TECHNOLOGY
05	FUNK = FUNK	13	PERC=PERCUSSION
06	HYBD = HYBIRD	14	SESS=SESSION
07	BLUE = BLUES	15	CHN = CHINA
08	JAZZ = JAZZ		

技术规格

显示: 负显段码液晶
鼓组: 15套预设鼓组
鼓曲: 10首鼓组
录音: 1组
CLICK: 拍数、节奏、速度、音量
MIDI功能: USB-MIDI, 自动电脑识别
效果器类型: Reverb
触发器: 3TOM (双触发)、1SNARE (双触发)、1HIHAT (双触发, 带止音)、1CRASH (双触发, 带止音)、1RIDE (双触发, 带止音)、1KICK
接口: 电源接口、OUTPUT接口、AUXIN接口、USB接口、CYMBAL拓展接口、耳机接口
电源: DC 9V外正内负, 工作电流200mA

*技术规格如有变更, 恕不另行通知。

有关产品中所含有害物质的说明

为了控制和减少电器电子产品废弃后对环境造成的污染, 本资料就本公司产品中所含的特定有害物质及其安全性予以说明。本资料适用于2016年7月1号以后本公司所制造的产品。

环保使用期限



此标志适用于在中国国内销售的电子信息产品, 表示环保使用期限的年数。所谓环保使用期限是指在制造日起的规定期限内, 产品中所含的有害物质不致引起环境污染, 不会对人身、财产造成严重的不良影响。环保使用期限仅在遵照产品使用说明, 正确使用产品的条件下才有效。不当的使用, 将会导致有害物质泄漏的危险。

产品中有害物质的名称及含量

部件名称	有害物质					
	铅 (Pb)	汞 (Hg)	镉 (Cd)	六价铬 (Cr(VI))	多溴联苯 (PBB)	多溴二苯醚 (PBDE)
主体	塑胶件	○	○	○	○	○
	五金件	×	○	○	○	○
	硅胶件	○	○	○	○	○
	内置电路板	×	○	○	○	○
附件	*交流电源适配器、线缆	×	○	○	○	○

*表示某些产品可能不含有这些项目, 上表当中的信息仅在产品含有这些项目时适用。

本表格依据SJ/T 11364的规定编制。

○: 表示该有害物质在该部件所有均质材料中的含量均在GB/T 26572规定的限量要求以下。

×: 表示该有害物质至少在该部件的某一均质材料中的含量超出GB/T 26572规定的限量要求, 因根据现有的技术水平, 还没有什么物质能够代替它。

保护环境

如果需要废弃本产品, 请遵循本地相关指引, 请勿随意丢弃或作为生活垃圾处理, 以避免对环境造成污染。

质量承诺

亲爱的 **NUX** 用户:

在您使用 **NUX** 产品时, 请仔细参阅产品说明书, 当您有疑问和困难时, 请拨打售后服务热线:

400-990-9866

- 一周内出现质量问题可退货退款
- 一年内出现质量问题可免费维修
- 一月内出现质量问题可调换
- 终身享有咨询和维修服务

[请向销售商索取正规发票并予以保存]

换修政策

一、包换政策:

1、消费者通过正规授权渠道购买的产品, 自购机之日起1个月之内, 在正常使用情况下出现非人为的产品性能故障, 且产品外观及包装保持完好, 可向所购机的经销商换机。

2、消费者在换机时应出示由经销商开出的购机凭证, 否则经销商可以不予更换。

二、保修政策:

1、消费者通过正规授权渠道购买的产品(以发票所示销售方为准), 自购买之日起1年内, 若出现非人为损坏的性能故障, 可享受免费维修服务。

2、对于超过1年或人为及不可抗力因素造成损坏的产品, 我司可提供有偿维修服务。

*本售后政策仅适用于中国大陆地区, 其它国家及地区以当地售后政策及法律法规为准。

售后服务地址: 广东省珠海市高新区唐家湾镇科技九路10号 珠海市蔚科科技开发有限公司 售后服务部 邮编: 519085

制造商: 深圳市蔚科电子科技有限公司 制造商地址: 深圳市南山区蛇口兴华路6号南海意库1号楼507
电话: 0755-2686 9866 网址: www.nuxefx.com 生产商: 珠海市蔚科科技开发有限公司
生产商地址: 珠海市高新区唐家湾镇科技九路10号 电话: 0756-3689 866 执行标准: Q/WKZDZ 003-2020

合格证

名称: 电子鼓

检验员:

型号: DM-210

生产日期:

本产品经检验合格
执行标准: Q/WKDZ 003-2020