

Digital Drum

Owner's Manual

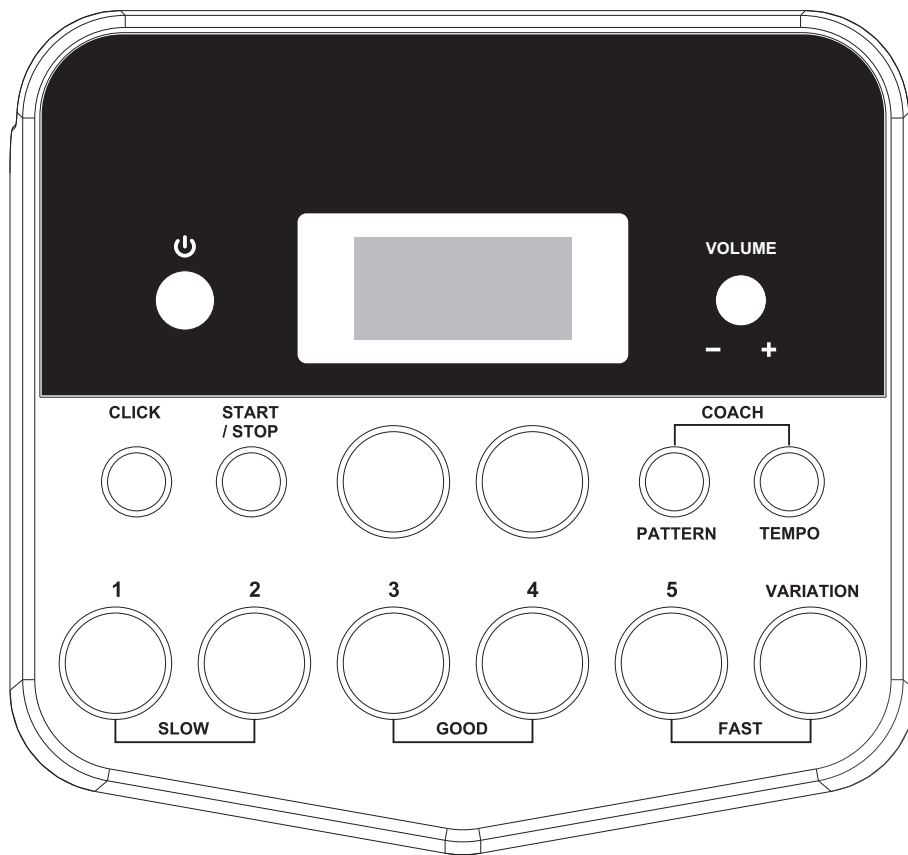

INFORMATION FOR YOUR SAFETY!

THE FCC REGULATION WARNING (for USA)

This equipment has been tested and found to comply with the limits for a Class B digital device, pursuant to Part 15 of the FCC Rules.

These limits are designed to provide reasonable protection against harmful interference in a residential installation. This equipment generates, uses, and can radiate radio frequency energy and, if not installed and used in accordance with the instructions, may cause harmful interference to radio communications. However, there is no guarantee that interference will not occur in a particular installation.

If this equipment does cause harmful interference to radio or television reception, which can be determined by turning the equipment off and on, the user is encouraged to try to correct the interference by one or more of the following measures:

- Reorient or relocate the receiving antenna.
- Increase the separation between the equipment and receiver.
- Connect the equipment into an outlet on a circuit different from that to which the receiver is connected.
- Consult the dealer or an experienced radio/TV technician for help.

Unauthorized changes or modification to this system can void the user's authority to operate this equipment.

CAUTION

The normal function of the product may be disturbed by Strong Electro Magnetic Interference. If so, simply reset the product to resume normal operation by following the owner's manual. In case the function could not resume, please use the product in other location.

CAUTION

Under the environment with electrostatic discharge and radio interference field, the sample may malfunction and need user power reset to recover sometimes.

PRECAUTIONS

PLEASE READ CAREFULLY BEFORE PROCEEDING

Please keep this manual in a safe place for future reference.

Power Supply

Please connect the designated AC adaptor to an AC outlet of the correct voltage.

Do not connect it to an AC outlet of voltage other than that for which your instrument is intended.

Unplug the AC power adaptor when not using the instrument, or during electrical storms.

Connections

Before connecting the instrument to other devices, turn off the power to all units. This will help prevent malfunction and / or damage to other devices.

Location

Do not expose the instrument to the following conditions to avoid deformation, discoloration, or more serious damage:

- Direct sunlight
- Extreme temperature or humidity
- Excessive dusty or dirty location
- Strong vibrations or shocks
- Close to magnetic fields

Interference with other electrical devices

Radios and televisions placed nearby may experience reception interference. Operate this unit at a suitable distance from radios and televisions.

Cleaning

Clean only with a soft, dry cloth.

Do not use paint thinners, solvents, cleaning fluids, or chemical-impregnated wiping cloths.

Handling

Do not apply excessive force to the switches or controls.

Do not let paper, metallic, or other objects into the instrument. If this happens, unplug the AC adaptor from the wall outlet. Then have the instrument inspected by qualified service personnel.

Disconnect all cables before moving the instrument.

Panel & Display Description

Front Panel.....	4
Rear Panel.....	4

QUICK START

Setup

Connecting Pads and Pedals.....	5
---------------------------------	---

Connections

Connecting an Audio Equipment.....	6
Connecting a set of Headphones.....	6
Connecting an MP3/CD Player.....	6
Connecting a Computer.....	6
Power Supply & Switch.....	6

Performing

Operation Feature.....	7
Playing the Pads.....	7
Selecting a Drum Kit.....	7
Playing along with Patterns.....	8
Using the Metronome/Click Feature.....	8
Adjusting the Tempo.....	8
Coach/Beat Check.....	9

ADVANCED USE

Playing with Drum Kit

About the Drum Kits.....	10
Selecting a Drum Kit.....	10
Adjusting the Volume of a Drum Kit.....	10

Setting the Metronome

About Metronome.....	11
Switching the Click on/off.....	11
Adjusting the Click Volume.....	11
Adjusting the Click Tempo.....	11

Selecting the Click Voice.....	11
Setting the Time Signature.....	12
Setting the Interval.....	12

Playing Back Pattern

About Patterns.....	13
Selecting a Pattern.....	13
Playing Back a Pattern.....	13
Adjusting the Pattern Volume.....	13

Practicing in Coach Mode

About Coach Mode.....	14
Coach Mode Control	14
Judging your Timing accuracy by Indicates.....	14
Beat Check.....	15
Gradual up/down.....	16
Change UP.....	17
Follow Me.....	18
Drum Mute.....	19

Making the Setting for MIDI

About MIDI.....	20
Connecting with an External Sound Device.....	20
Using the Digital Drum as a Sound Module.....	20

Troubleshooting.....	21
----------------------	----

Specifications.....	21
---------------------	----

APPENDICES

Kit List.....	22
GM Kit List.....	23
GM Backing Instrument List.....	24
Pattern List.....	25
Loop List.....	26
MIDI Implementation Chart.....	27

Panel Description

Front Panel

- 1. POWER Button**
Use this button to turn the drum module on and off.
- 2. VOLUME Knob**
Adjusts the volume of headphone and line output.
- 3. CLICK Button**
Turn the metronome on or off.
- 4. START/STOP Button**
Start or stop playing patterns.
- 5. + Button, - Button**
These buttons are used to change values when editing. The + button increases the value, and the - button decreases it.
- 6. PATTERN Button**
Enter the Pattern mode.
- 7. TEMPO Button**
Adjust the current tempo.
- 8. PATTERN + TEMPO Button**
Press the PATTERN and TEMPO buttons simultaneously to enter the Coach mode.
- 9. 1~5/VARIATION Buttons**
Enter the Kit mode and choose a kit.
Choose a coach type in the Coach Mode.

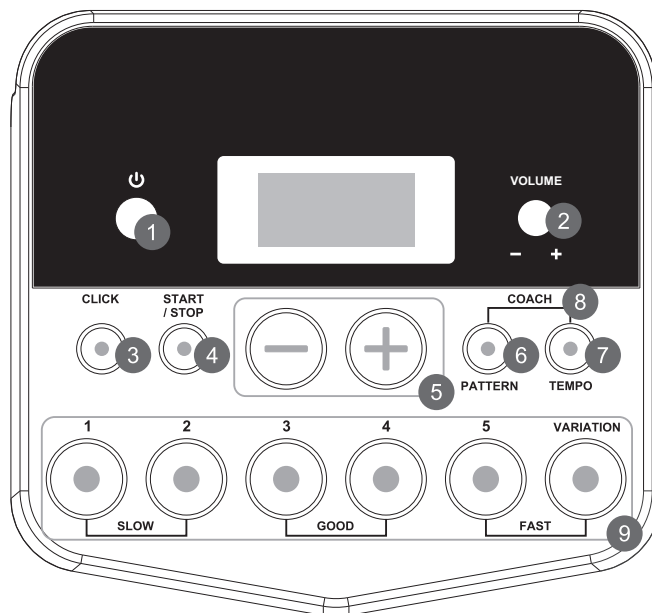

CLICK + 1: Enter the click voice menu.

CLICK + 2: Enter the time signature menu.

CLICK + 3: Enter the interval menu.

Rear Panel

- 10. PHONES Jack (1/8")**
This stereo jack is used to connect the headphones to this unit.
- 11. AUX IN Jack (1/8")**
This stereo input jack is for an external sound source, such as an MP3 or CD player.
- 12. LINE OUTPUT Jacks(1/4")**
Stereo output connection to an audio system or drum amplifier.
- 13. USB Connector**
This port is used to connect to a computer (MIDI In/Out via USB).
- 14. DC IN Jack**
Connect the included DC 9V power adaptor.
- 15. PAD Connectors**
Input connections for Snare, Toms, Cymbal Pads, Hi-Hat pedal and Kick pedal.

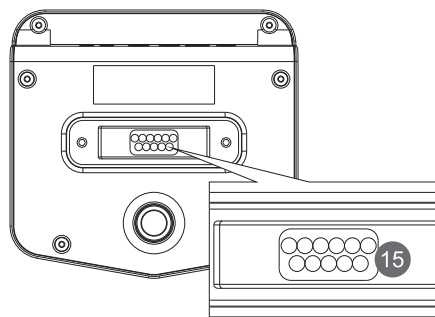
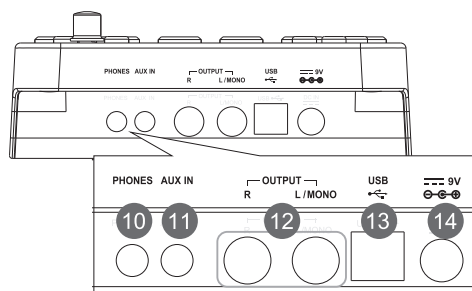

Caution!

To prevent electric shock and damage to the device, make sure the power is switched OFF on the drum and all related devices before making any connection.

Connecting Pads and Pedals

Standard: KICK, SNARE, TOM1-3, CRASH, RIDE, HI-HAT and HI-HAT PEDAL.

Using the provided cables to connect with kick pedal, snare, tom1~tom3, ride, crash, hi-hat and hi-hat pedal. These pads and pedals are all mono input and velocity sensitive.

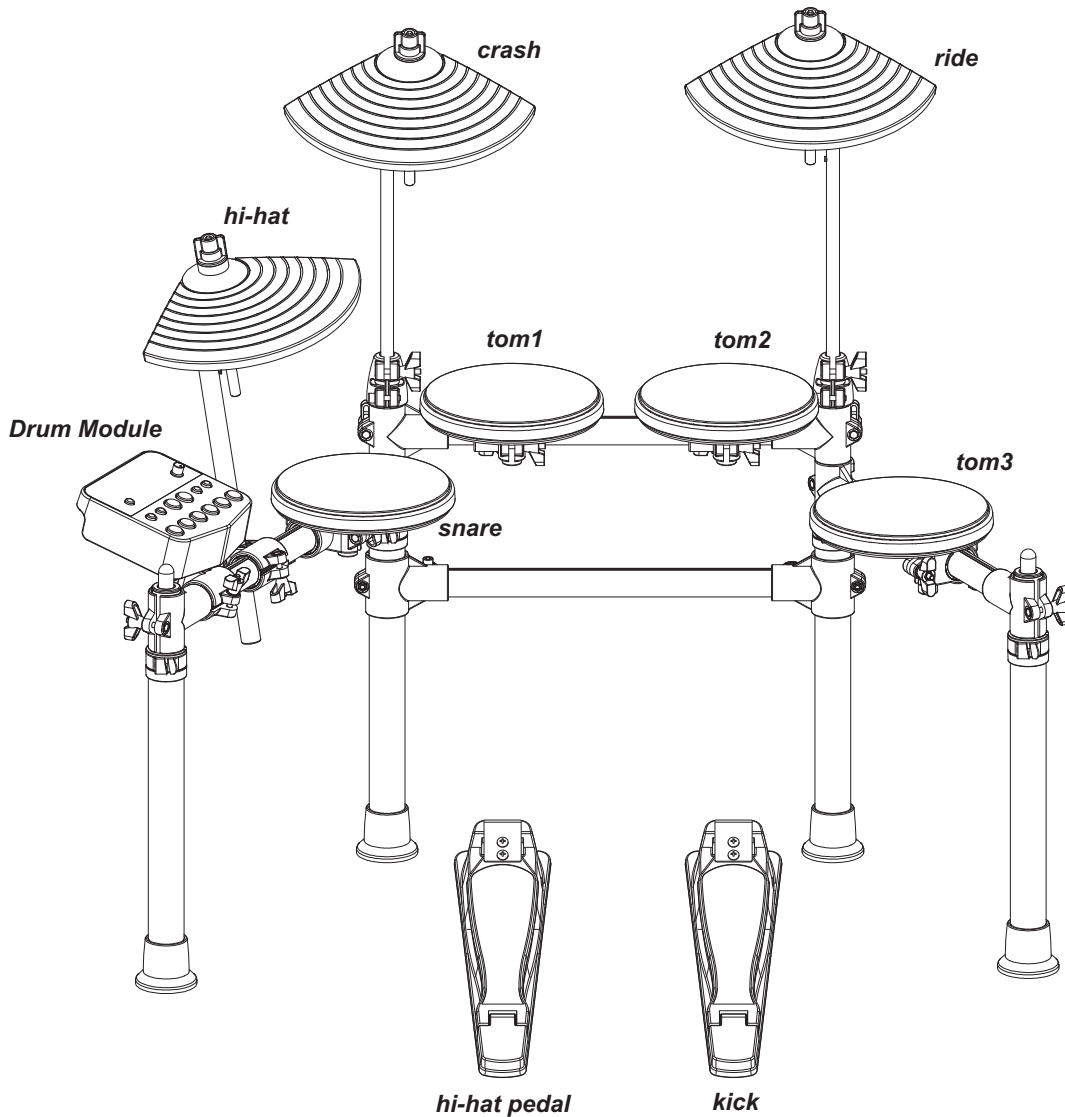

Note:

For details on assembling the drum stand, attaching the digital drum and connecting pads, refer to the Installation manual.

Connections

Connecting an Audio Equipment

When using an amplifier, connect the Output L/MONO and R jacks on the rear panel to the input jack of the amplifier.

Note:

Turn off the power of all devices before you make connections.
For mono playback, use the L/MONO jack.
For stereo playback, connect both L/MONO and R jacks.
The line output volume is controlled by the VOLUME knob.

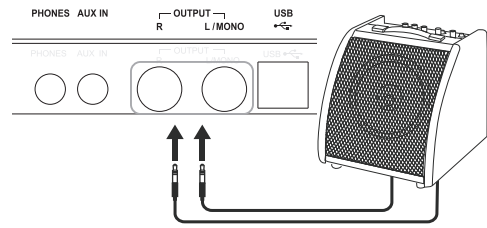

Connecting a set of Headphones

An optional set of stereo headphones can be connected to the PHONES jack located on the rear panel of the drum module. The headphones output volume is controlled by the VOLUME knob too.

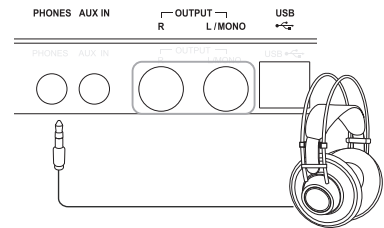

Connecting an MP3/CD Player

Connect the audio output of an MP3/CD player or other audio source to the stereo AUX IN jack on the rear panel. The input signal is mixed with the drum signal, allowing you to play along.

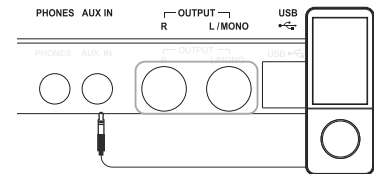

Connecting a Computer

By connecting a computer to the USB terminal, you can transfer MIDI data between the module and the computer.

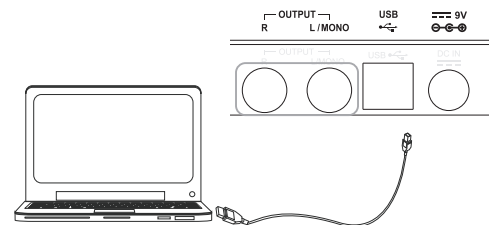

Power Supply & Switch

Connect the power adaptor to the DC IN jack on the rear panel. After confirming that all connections have been completed, rotate the volume knob to the left (minimum volume level) before switching the power on. Press the [POWER] button to turn on the power.

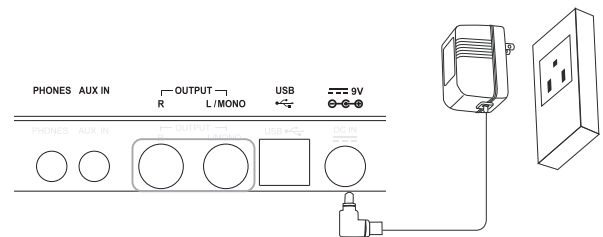

AUTO POWER OFF

The digital drum will automatically turn off the power, if there is no operation for about 30 minutes.

Press the [START/STOP] button and then turn on the power to switch off the auto power off function. It will display "PoF" for a while.



Operation Feature

■ Enter the Volume Page

Double click the corresponding buttons, enter the Volume pages.

For example:

Double click the [PATTERN] button to enter pattern volume page.

Double click the numeric button [1] ~ [5] to enter kit volume page.

Double click the [CLICK] button to enter click volume page.



Click Twice

■ The numeric buttons (1~5) can be used as a combination with other buttons.

In kit mode, combine the numeric buttons (1~5) with the [VARIATION] button to select a kit.

In Coach mode, the numeric buttons (1~5) can be used to select a coach type.

Combine the numeric buttons (1~3) with the [CLICK] button to select the click parameter menu.

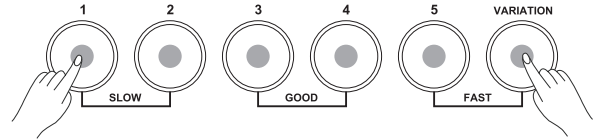

Playing the Pads

Similar to an acoustic drum kit, the digital drum responds differently to various playing techniques and dynamics. All the pads are velocity sensitive, and some voices change timbre depending on the striking force.

Hi-Hat

The Hi-Hat sounds varies from open to closed in response to how far the Hi-hat pedal is pressed:

Open Hi-Hat: Strike the Hi-Hat pad without pressing the pedal.

Closed Hi-Hat: Strike the Hi-Hat pad with the pedal pressed completely down.

Pedal Close: Press the pedal completely down without striking the pad.

Splash: Press the pedal completely down and release it immediately.

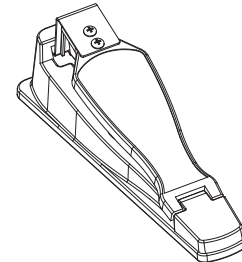

Selecting a Drum Kit

After the power is turned on, the digital drum displays the KIT menu. As the picture shows:

- There are 10 preset kits for your choice.
The [VARIATION] button LED remains in red: select kit 1~5 by the numeric button 1~5.
The [VARIATION] button LED remains in green: select kit 6~10 by the numeric button 1~5.



- Hit the pads to play the current kit.

Performing

Playing along with Patterns

There are 30 patterns in this drum module.

1. Press the [PATTERN] button to enter pattern menu.
The [PATTERN]'s LED will be lighten.
2. Press the [+] or [-] button to adjust the pattern number.
3. Press the [START/STOP] button to start/stop pattern playing.
For details on patterns playing, refer to **ADVANCED USE**.

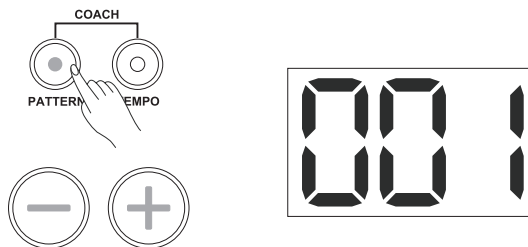

Using the Metronome/Click Feature

You can switch the click sound on or off by pressing the [CLICK] button. When the click plays at the current Time Signature and Tempo, the beat LED will shining at the current beat point. You can set the time signature and interval, adjust the click volume and select the click sound in the CLICK menu.

1. Press the [CLICK] button to start the metronome.
Press the [CLICK] button again to stop the metronome.
2. Press and hold the [CLICK] button, and then press one of the numeric buttons [1~3] to select the click menu page and press the [+] or [-] button to adjust the value.

For details on Metronome, refer to **ADVANCED USE**.

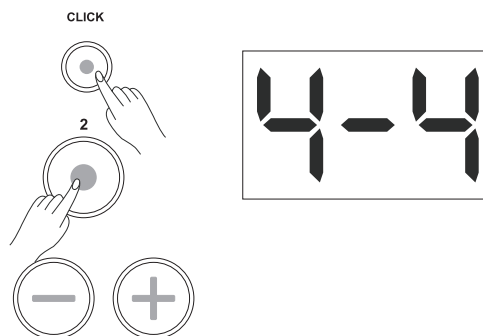

Adjusting the Tempo

You can adjust the tempo of the Metronome, the current pattern, and the current rhythm/coach pattern.

1. Press the [TEMPO] button.
2. Press the [+] or [-] button to adjust the current tempo.
3. Press the [+] and [-] buttons simultaneously to reset the current tempo to its default value.

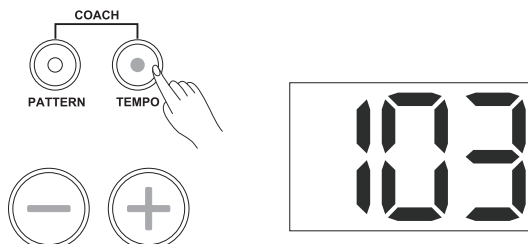

Note:

If there's no operation in 4 seconds, the module will automatically return to the previous menu page.

Coach/Beat Check

Beat Check type is designed for training your accurate beat with metronome.

1. Press the [PATTERN] and [TEMPO] buttons simultaneously, you can enter the coach mode. The LED of [PATTERN] and [TEMPO] buttons will be lighted.
In coach mode, press the [1] button.
Select the Beat Check training type.

2. Press the [START/STOP] or [CLICK] button.
Start or stop practicing. You can hit pads following with the metronome. The 6 LEDs on the bottom of the drum module will show your hitting accuracy.

Note:

1. You can set the beat type (3-4,4-4,etc)before start practicing; refer to the **Setting the Metronome** for more details.
2. Before starting practicing, you can adjust the tempo value at the same time.

For more about coach type, please refer to **ADVANCED USE**.

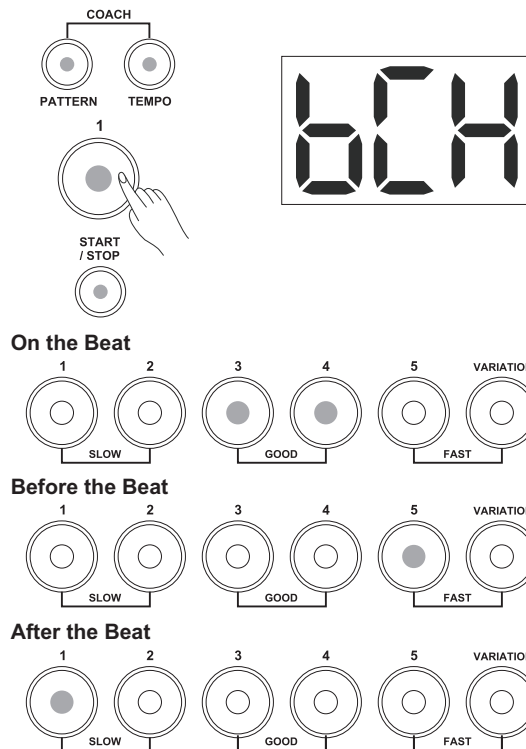

Playing with Drum Kit

About the Drum Kits

It is very easy to select a drum kit to play. What's more, you can also adjust the volume of each kit.

There are 10 kits in this digital drum.

Selecting a Drum Kit

Press the numeric button [1] ~ [5] with [VARIATION] button to select a drum kit.

1. The [VARIATION] button's back LED can toggle between red and green by pressing the [VARIATION] button.
2. When the [VARIATION] button's back LED in red, you can select kit 1~5 by pressing the numeric button [1] ~ [5].
3. When the [VARIATION] button's back LED in green, you can select kit 6~10 by pressing the numeric button [1] ~ [5].

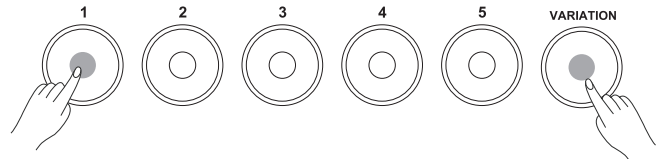

[VARIATION]	[1]	[2]	[3]	[4]	[5]
RED	KIT1	KIT2	KIT3	KIT4	KIT5
GREEN	KIT6	KIT7	KIT8	KIT9	KIT10

Adjusting the Volume of a Drum Kit

Each drum kit has its own volume value, and it can be set independently.

1. By double clicking the numeric button [1] ~ [5], you can select the volume page of a kit.
2. You can adjust the volume of current kit from 0 ~ 32 by pressing the [+] or [-] button. If there isn't any operation more than 4 seconds, the drum machine will automatically exit the volume page. The default value is 28.



Setting the Metronome

About Metronome

The digital drum is equipped with a built-in metronome, which can be used as a rhythm guide for practice, or in conjunction with the pattern playback.

You can set the click voice, time-signature, interval and volume.

Operation	Menu	Display
[CLICK]+[1]	Click Voice	CL1~CL5
[CLICK]+[2]	Time Signature	1-2,2-2,3-4,4-4,6-8
[CLICK]+[3]	Interval	2,4,8,16,3,6
Double Click [CLICK]	Volume	0~32

Switching the Click on/off

1. Press the [CLICK] button to start the metronome.
The CLICK LED will flash, indicating that the metronome will play at the current time signature and tempo.
2. Press the [CLICK] button again to stop the metronome.

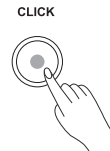

Adjusting the Click Volume

1. Double click the [CLICK] button to select the Click Volume page.
The display will show: 0~32.
The default value is 25.
2. Press the [+] or [-] button to adjust the volume.

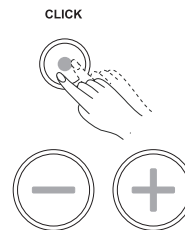

Adjusting the Click Tempo

Press the [TEMPO] button, use the [+] or [-] button to adjust the value of current click tempo.
The tempo range: 30~280.

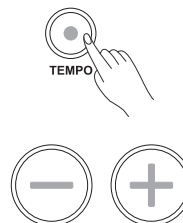

Selecting the Click Voice

1. Press the [CLICK] and [1] buttons simultaneously, the click voice page will be selected.
2. Press the [+] or [-] button to change the current click voice.
There are 5 voices you can choose: CL1~CL5, and the default value is CL1.

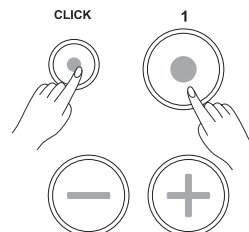

Display	Description
CL1	MEBL/ MECK
CL2	CLAVE
CL3	STICK
CL4	COCLICK
CL5	VOCAL

Setting the Metronome

Setting the Time Signature

1. Press the [CLICK] and [2] buttons simultaneously, the time signature page will be selected.

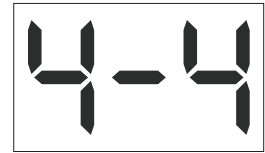
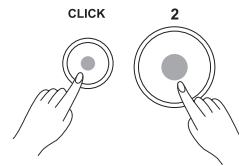

2. Press the [+] or [-] button to change the current time signature. There are 5 types you can choose: 1-2, 2-2, 3-4, 4-4 and 6-8, the default value is 4-4.

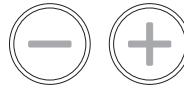

Setting the Interval

1. Press the [CLICK] and [3] buttons simultaneously, the interval page will be selected.

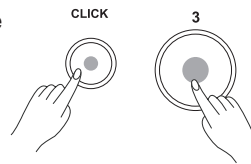

2. Press the [+] or [-] button to change the current interval. There are 6 types you can choose: 2, 4, 8, 16, 3 and 6, the default value is 4.



Notes:

If the length of the interval is longer than a beat, it can't be selected.

For example: If the time signature is 4-4, a beat is a quarter note. The interval of 2 is longer than it, so it can't be selected.

Display	Description
2	half note
4	quarter note
8	eighth note
16	sixteenth note
3	triplet
6	sextuplet

Playing Back Pattern

About Patterns

There are 30 preset patterns in this digital drum, please refer to the Pattern List for details. In Pattern mode, you can select the pattern number and adjust the volume of the pattern.

Selecting a Pattern

1. Press the [PATTERN] button to enter pattern mode. The Pattern indicator will light up, and the 3-digit LED will display the number of current pattern.
2. Press the [+] or [-] button to select a pattern. Holding down the [+] button, the pattern number increase rapidly, while holding down the [-] button, it decreases rapidly.

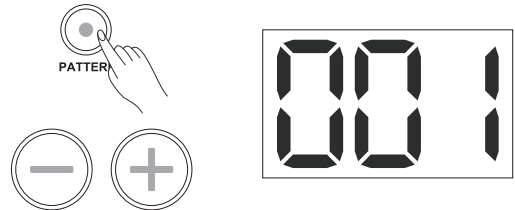

Playing Back a Pattern

1. Press the [START/STOP] button to start playing back pattern.
2. Press the [START/STOP] button again, stop playing back the pattern.



Adjusting the Pattern Volume

1. Double click the [PATTERN] button, and then the pattern volume page will be selected.
2. Use the [+] or [-] button to adjust it. It will restore to default value on the next power on.
3. If there isn't any operation in pattern volume page for more than 4 seconds, it will automatically return back to the last menu. The range of pattern volume: 0~32. And the default value is 25.

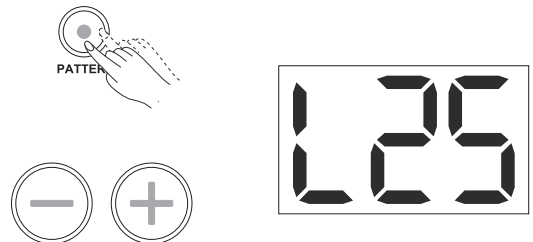

Practicing in Coach Mode

About Coach Mode

The Coach mode is a unique set of exercises. Specifically designed for those learners who want to improve their tempo, accuracy and stamina, as well as developing a better drum skill.

According to your present skills, you can select an appropriate coach type to practice.

There are 5 coach types in this digital drum:

Display	Coach Type	Description
Bch	Beat Check	only metronome accuracy practice.
Gud	Gradual Up/Down	metronome accuracy practice with speed up/down.
C-U	Change Up	3 rhythms group to train your beat accuracy.
FLO	Follow me	12 percussion loops to train your beat accuracy.
d-U	Drum Mute	30 patterns to practice any drums' beat accuracy.

Coach Mode Control

Press the [PATTERN] and [TEMPO] buttons simultaneously to enter the coach mode. Both of the [PATTERN] and [TEMPO] LEDs will be turned on.

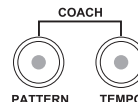

The display will show:

In this coach mode, press the numeric button 1~5 to select a type from the five coach types.



There are 2 states in coach mode (except beat check mode).

- Preparation: adjust parameters, get ready to practice.
- Practice: practice in the selected type.

Press the [START/STOP] button for the first time, the module is on preparation to start practicing. (Except beat check type). Press the [START/STOP] again, the practice mode starting, and your hitting accuracy will be indicated by 6 LEDs on the bottom of the drum module.

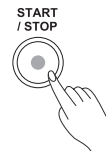

Press the [PATTERN] and [TEMPO] buttons simultaneously to exit the coach mode.

Judging your Timing accuracy by Indicators

GOOD (On the Beat)

If the time point of your hitting is just on the standard beat, both of the [3] and [4] LEDs will flashing for a moment in green.

FAST (Before the Beat)

If the time point of your hitting is earlier than the standard beat, the LED of [5] button or [VARIATION] button will flashing for a moment in red. You need to slow down.

1. The LED of [5] button is flashing, it means you were playing a little early than the standard beat.
2. The LED of [VARIATION] is flashing, it means you were playing so early than the standard beat.

On the Beat

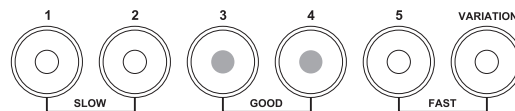

Before the Beat

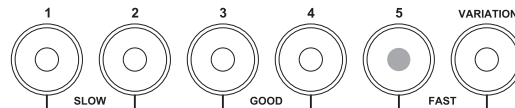

SLOW (After the Beat)

If the time point of your hitting is later than the standard beat, the LED of [1] or [2] button will flashing for a moment in red. You need to speed up.

1. The LED of [2] button is flashing, it means you were playing a little later than the standard beat.
2. The LED of [1] button is flashing, it means you were playing so later than the standard beat.

After the Beat

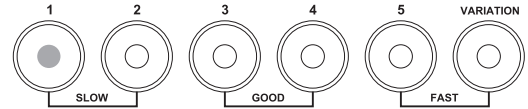

OUT OF BEAT

None of the 6 LEDs is flashing means you were playing out of beat, maybe you need more practice and try your best next time.

Beat Check

In order to improving your timing, you can practice with metronome in all sorts of time signature and intervals in this beat check mode. The lighted numeric button and [VARIATION] button is used to show how early or late you are drumming.

You can practice like this.

1. In coach mode, press the [1] button to enter the beat check type.
2. Set time-signature and interval you want to practice. Please refer to the "Setting the metronome" chapter for metronome parameter settings.
3. Press the [START/STOP] button or the [CLICK] button to start beat check training. Your hitting accuracy will be indicated by 6 LEDs on the bottom of the drum module.
4. Press the [START/STOP] button or the [CLICK] button to stop beat check training.

Note:

During beat check training, the time-signature and interval can't be changed.

For example: 4/4 Practice

1. Select the beat check type
Press the [PATTERN] and [TEMPO] buttons simultaneously to enter Coach mode.
Press the [1] button to select beat check type.
2. Select your desired time signature and interval.
Press and hold the [CLICK] button, and then click the [2] button to call up the time signature page. Pressing the [+] or [-] button to select time signature "4-4".
Press and hold the [CLICK] button, and then click the [3] button to call up the interval page. Pressing the [+] or [-] button to select interval "4".
3. Practicing with Beat Check.
Press the [START/STOP] button, the metronome will playing with 4/4.
Please strike the pad following the metronome.
Your hitting accuracy will be indicated by the 6 LEDs on the bottom of the drum module.

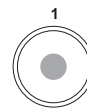
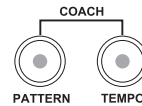

Practicing in Coach Mode

Gradual up/down

In gradual up/down type, you can see how fast you can go and still maintain accurate timing.

Practicing with metronome in all sorts of time signature and intervals. As you play along with a metronome, the drum will automatically increase the tempo if your timing is good and decrease it if not.

There are two training ways in this type:

G-1: The tempo will auto decrease or increase 5 BPM depend on your timing accuracy every 4 measures.

1. If you have hit above 80% beats correctly in 4 measures, the tempo value will increase 5 BPM.
2. If you have hit between 40% to 80% beats correctly in 4 measures, the tempo won't change and keep its value.
3. If you have hit lower than 40% beats correctly in 4 measures, the tempo value will decrease 5 BPM.

G-2: The tempo will increase or decrease by 1BPM each measure.

In G-2, you can set initial tempo value before practice.

During tempo increasing, it will turn back to decrease by pressing the [TEMPO] button.

You can practice like this.

1. In coach mode, press the [2] button to enter this type.
2. Press the [START/STOP] button to enter Gradual Up/Down preparation. The LED of the [START/STOP] button starts flashing.
3. Press the [1] button to choose G-1 type, or press the [2] button to choose G-2 type.
Set time-signature and interval you want to practice. Please refer to the "Setting the metronome" chapter for metronome parameter settings.
4. Press the [START/STOP] button to start gradual up/down practicing. The current tempo value will be displayed on the 3-digit LED. Your hitting accuracy will be indicated by the 6 LEDs on the bottom of the drum module.
5. Press the [START/STOP] button to stop gradual up/down practicing.

For example: G-1 practice

1. Select the Gradual Up/Down type.
Press the [PATTERN] and [TEMPO] buttons simultaneously to enter Coach mode.
Press the [2] button to select gradual up/down type.
Press the [START/STOP] button to enter preparation.
Press the [1] button to select "G-1" training.
2. Select your desired time signature, interval and tempo.
Press and hold the [CLICK] button, then click the [2] button to call up the time signature page. Press the [+] button or [-] button to select time signature "4-4".
Press and hold the [CLICK] button, then click the [3] button to call up the interval page. Press the [+] or [-] button to select interval "4".
Press the [TEMPO] button, and then press the [+] or [-] button to adjust the current tempo to 60 BPM.
3. Practicing with G-1
Press the [START/STOP] button to start practicing with 4/4 and 60 BPM.
The tempo will auto increase 5BPM depending on your accuracy every 4 measures.
Your hitting accuracy will be indicated by 6 LEDs on the bottom of the drum module.



Change UP

In change up type, you can choose one rhythm group to practice with. Maintain good timing as you play along with up to three different practice rhythms that change every two measures. And the display will flash for times when the rhythm is ready to change. The rhythm type changes in circle.

If the digital drum is not yet in change up mode, press the [3] button to enter this type.

You can practice like this:

1. Press the [START/STOP] button to enter the CHANGE UP preparation. The LED of the [START/STOP] button starts flashing.
2. Press numeric button [1] ~ [3] to choose one rhythm group. It will display like this:
3. Press the [START/STOP] button to start current change up practice. It will display current rhythm type. Your hitting accuracy will be indicated by the six LEDs on the bottom of the drum module
4. Press the [START/STOP] button to stop practice. After one cycle, you can see your score on the 3 digit LED, and your can hear a comment according to your performance.

Rhythm Group	Display	Description
P-1	2-4-8-3-16	
P-2	2-4-3-8-3-16	
P-3	2-4-3-8-3-16-6	

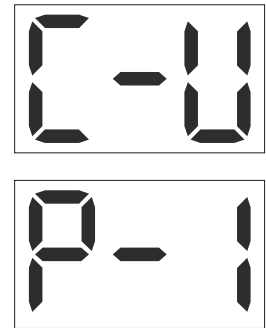
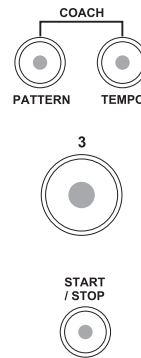

Scoring Rule:

1. While you are playing, and the LED 3 and LED 4 light up: Plus 3 points to your score.
2. While you are playing, and the LED 2 or LED 5 lights up: Plus 2 points to your score.
3. While you are playing, and the LED 1 or LED VARIATION lights up: Plus 1 point to your score.
4. While you are playing, and none of the LEDs lights up: Minus 1 point to your score.
5. While the rhythm is playing, if you haven't hit the pad: no change to your score.
(This scoring rule uses a percentage grading system.)

So, try your best and do not make any mistake as you can while you are practicing. Good luck!

Comment:

If you get the score from 0 to 29, you will hear the comment "OK!".
If you get the score from 30 to 59, you will hear the comment "GOOD!".
If you get the score from 60 to 79, you will hear the comment "VERY GOOD!".
If you get the score from 80 to 100, you will hear the comment "EXCELLENT!".

Score	Comment
0~29	OK
30~59	GOOD
60~79	VERY GOOD
80~100	EXCELLENT

Practicing in Coach Mode

For example: Practice in P-1

1. Select the Change Up.
Press the [PATTERN] and [TEMPO] buttons simultaneously to enter Coach mode. Press the [3] button to select change up type. Press the [START/STOP] button to enter preparation. Press the [1] button to select "P-1" training.
2. Select your desired tempo.
Press the [TEMPO] button, and then press the [+] or [-] button to adjust current tempo to 60 BPM.
3. Practicing with P-1
Press the [START/STOP] button to start practice. Your hitting accuracy will be indicated by the 6 LEDs on the bottom of the digital drum.
After one cycle, the practice will stop automatically. Your score will be displayed on the 3-digit LED, and you will hear your comment.



Follow Me

In follow me type, there are 12 drum-loops from easy to hard level. (Please refer to the Loop List and the Drum Score manual.)

These loops play circularly: once sound out, and once muted. So you can listen and memorize when it sound out, and you can hit by yourself when it muted. By this training, you can distinguish each kind of drum more accurately. The hitting accuracy and your memory can be also advanced.

You can practice like this:

1. In coach mode, press the [4] button to enter this type.
2. Press the [START/STOP] button to enter FOLLOW ME preparation. The LED of the [START/STOP] button starts flashing.
3. Select drum loops you want to practice by pressing the [+] or [-] button.
4. Press the [START/STOP] button to start practicing. When current loop sound out, it will display "1-2-3-4", when it muted, it will display "F-1, F-2, F-3, and F-4".
Your hitting accuracy will be indicated by the 6 LEDs on the bottom of the drum module.

Note:

You can't change drum-loops when you are practicing.

5. Press the [START/STOP] button again to stop practicing.

For example: Practice in 001.

1. Select the Follow Me.
Press the [PATTERN] and [TEMPO] buttons simultaneously to select Coach mode. Press the [4] button to select follow me type. Press [START/STOP] button to enter the preparation. Press the [+] or [-] button to select loop 001.
2. Practicing with 001.
Press the [START/STOP] button to start practicing. Press the [START/STOP] button again to stop practicing. Your hitting accuracy will be indicated by 6 LEDs on the bottom of the drum module.

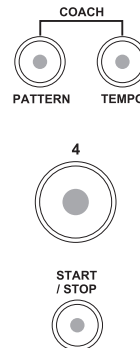

Drum Mute

In drum mute type, there are 30 patterns to practice from easy to hard. In this mode, the numeric buttons [1] ~ [5] and the [VARIATION] button stand for one part of drum. These buttons can be used to open or mute drum's play. (As described in the table) One part of drum is muted when its corresponding LED light up.

With these settings, you can play freely in each pattern. And we also provided you the Drum Score manual to follow with.

You can practice like this:

1. In coach mode, press the [5] button to enter this type.

2. Press the [START/STOP] button to enter the DRUM MUTE preparation. The LED of the [START/STOP] button starts flashing.

3. Select which pattern you want to practice by pressing [+] or [-] button. Select drums you want to open or mute by pressing the [1] ~ [5] or [VARIATION] button.

4. Press the [START/STOP] button to start practicing.

5. Press the [START/STOP] button again to stop practicing.

For example: Practice in 001

1. Select the Drum Mute.

Press the [PATTERN] button and [TEMPO] buttons simultaneously to enter Coach mode.

Press the [5] button to select drum mute type.

Press the [START/STOP] button to enter the preparation. Press the [+] or [-] button to select practice pattern 001.

2. Select the parts you want to mute.

Press the [2] button to mute snare part.

3. Practicing with 001.

Press the [START/STOP] button to start practicing.

No hitting accuracy, no comment, and just play as you like.

Press the [START/STOP] button to stop practicing.

Light Button	[1]	[2]	[3]	[4]	[5]	[VARIATION]
Part Mute	Kick	Snare	Hi-Hat	Tom	Cymbal (Crash and Ride)	Percussion

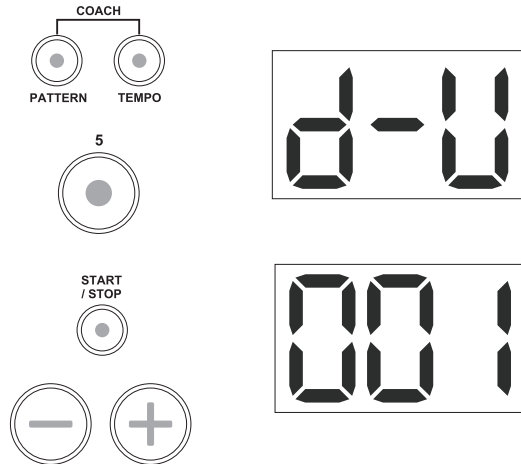

Making the Settings for MIDI

About MIDI

MIDI (Musical Instrument Digital Interface) is a standard that allows performance data and other information to be exchanged among electronic musical instruments and computers. With a MIDI cable connecting MIDI connectors equipped device, you can play multiple instruments with a single electronic musical instrument, have multiple instruments perform in ensemble, program the settings to change kits automatically to match the performance as the song progresses, and more.

USB Connection

The USB connector allows you to connect the digital drum directly to your computer. It can be connected without installing a driver in Windows XP/Vista/Win7 or MAC OSX environments. The digital drum will be recognized as a “USB Audio device” to receive and transmit MIDI messages through a single USB cable. The USB port is used only for MIDI messages (MIDI via USB)

Note:

When the USB port is connected to a computer, all MIDI messages will be received and transmitted via USB.

Connecting with an External Sound Device

The digital drum transmission channel for the drum kit is fixed to Channel 10. It will output MIDI data generated by the triggers when hitting the pads or stepping on the Hi-Hat control pedal (Note ON/OFF, and Foot messages). Song playback data and metronome notes are not transmitted.

Recording Your Performance to an External Sequencer

1. If you are using a software sequencer on a computer, you can simply connect the USB port of the digital drum to a USB port of your computer using a single USB A-B cable.
2. Setup the active track of your sequencer on Channel 10. Activate RECORD on your sequencer.
3. Play the pads of your digital drum.
4. Stop recording. Locate your sequencer to the start of your recording.
5. Playback the recorded sequencer.

Trigger	MIDI Note	Trigger	MIDI Note	Trigger	MIDI Note	Trigger	MIDI Note	Trigger	MIDI Note
Kick	36	Snare	38	Tom1	48	Tom2	45	Tom3	43
Ride	51	Crash	49	Hi-Hat O	46	Hi-Hat P	44	Splash	21

Using the Digital Drum as a Sound Module

Connecting an external keyboard or sequencer to the MIDI Input allows you to use the digital drum as a multi-part, polyphonic sound module to play various instrument parts in addition to your drums (for instance, Piano on Channel 1, Bass on Channel 2, Strings on Channel 3, etc). The voices on each MIDI channel are selected using MIDI Program Change messages (refer to **GM Backing Instrument List**).

The MIDI system in the digital drum has 16 reception channels numbered from 1-16. Each of the channels is responsible for a voice. When the instrument receives MIDI information from an external device, the active channel is determined by the control message. Channel 10 is reserved for Drums.

Note:

For more information on received MIDI messages, refer to MIDI implementation chart.

Problem	Possible Cause and Solution
No Sound	1) Rotate the [VOLUME] knob to be sure that the volume isn't down.
No Sound from Pads	1) To be sure that the pad is connected correctly. 2) To be sure not set the volume of the pad to 0
No Click Sound	1) To be sure not set the volume of the click to 0.
Sound is Distorted	1) Turn down the volume.

Specifications

Maximum Polyphony

64

Drum Kits

10 Preset Kits

General MIDI Kits

5 GM Kits

Sequencer

30 patterns
12 drum loops

Resolution

192 ticks per quarter note

Tempo

30~280

Display

3-digit LED

Connectors

25-Pin Trigger Input Jack, Phones Jack, Aux In, Line Output (R, L/MONO), USB MIDI, DC IN Jack

Pad Select Buttons

1 Snare Pad, 3 Tom Pads, 1 Crash Cymbal, 1 Ride Cymbal, 1 Hi-Hat Cymbal, 1 Hi-Hat Pedal, 1 Kick Pedal

Power Supply

DC 9V

Dimensions (Sound Module)

147.1(W) × 183.3(H) × 111.7(D) mm

Weight (Sound Module)

0.5 kg

* All specifications and appearances are subject to change without notice.

Kit List

NO.	PRESET KIT
1	Acoustic
2	Funk
3	JazzBrush
4	Rock
5	808
6	909
7	FX Mix
8	Marimba
9	Indian
10	Percussion

GM Kit List

Note No.	Standard (bank 00)	Funk (bank 08)	Rock (bank 16)	Electric (bank 24)	Brush (bank 40)
27-D#1	High Q	<-	<-	<-	<-
28-E1	Slap	<-	<-	<-	<-
29-F1	Scratch Push	<-	<-	<-	<-
30-F#1	Scratch Pull	<-	<-	<-	<-
31-G1	Sticks	<-	<-	<-	<-
32-G#1	Square Click	<-	<-	<-	<-
33-A1	Metronome Click	<-	<-	<-	<-
34-A#1	Metronome Bell	<-	<-	<-	<-
35-B1	Acoustic Bass Drum	<-	<-	<-	<-
36-C2	Standard Bass Drum	Funk Bass Drum	Rock Bass Drum	Electric Bass Drum	Brush Bass Drum
37-C#2	Side Stick	<-	<-	<-	<-
38-D2	Standard Snare	Funk Snare	Rock Snare	Electric Snare	Brush Snare
39-D#2	Hand Clap	<-	<-	<-	<-
40-E2	Standard Snare Rim	Funk Snare Rim	Rock Snare Rim	Electric Snare Rim	Brush Snare Rim
41-F2	Standard Tom 6	Funk Tom 6	Rock Tom 6	Electric Tom 6	Brush Tom 6
42-F#2	Standard Hi-hat Close	<-	<-	<-	<-
43-G2	Standard Tom 5	Funk Tom 5	Rock Tom 5	Electric Tom 5	Brush Tom 5
44-G#2	Standard Hi-hat Pedal	<-	<-	<-	<-
45-A2	Standard Tom 4	Funk Tom 4	Rock Tom 4	Electric Tom 4	Brush Tom 4
46-A#2	Standard Hi-hat Open	<-	<-	<-	<-
47-B2	Standard Tom 3	Funk Tom 3	Rock Tom 3	Electric Tom 3	Brush Tom 3
48-C3	Standard Tom 2	FunkTom 2	Rock Tom 2	ElectricTom 2	BrushTom 2
49-C#3	Standard Crash 1	<-	<-	<-	<-
50-D3	Standard Tom 1	Funk Tom 1	Rock Tom 1	ElectricTom 1	Brush Tom 1
51-D#3	Standard Ride	<-	<-	<-	<-
52-E3	Chinese Cymbal 1	<-	<-	<-	<-
53-F3	Ride Bell	<-	<-	<-	<-
54-F#3	Tambourine	<-	<-	<-	<-
55-G3	Splash Cymbal	<-	<-	<-	<-
56-G#3	Standard Cowbell	<-	<-	<-	<-
57-A3	Standard Crash 2	<-	<-	<-	<-
58-A#3	Vibra-slap	<-	<-	<-	<-
59-B3	Ride Cymbal	<-	<-	<-	<-
60-C4	Hi Bongo	<-	<-	<-	<-
61-C#4	Low Bongo	<-	<-	<-	<-
62-D4	Mute Hi Conga	<-	<-	<-	<-
63-D#4	Open Hi Conga	<-	<-	<-	<-
64-E4	Low Conga	<-	<-	<-	<-
65-F4	High Timbale	<-	<-	<-	<-
66-F#4	Low Timbale	<-	<-	<-	<-
67-G4	High Agogo	<-	<-	<-	<-
68-G#4	Low Agogo	<-	<-	<-	<-
69-A4	Cabasa	<-	<-	<-	<-
70-A#4	Maracas	<-	<-	<-	<-
71-B4	Short Whistle	<-	<-	<-	<-
72-C5	Long Whistle	<-	<-	<-	<-
73-C#5	Short Guiro	<-	<-	<-	<-
74-D5	Long Guiro	<-	<-	<-	<-
75-D#5	Claves	<-	<-	<-	<-
76-E5	Hi Wood Block	<-	<-	<-	<-
77-F5	Low Wood Block	<-	<-	<-	<-
78-F#5	Mute Cuica	<-	<-	<-	<-
79-G5	Open Cuica	<-	<-	<-	<-
80-G#5	Mute Triangle	<-	<-	<-	<-
81-A5	Open Triangle	<-	<-	<-	<-
82-A#5	Shaker	<-	<-	<-	<-
83-B5	Jingle Bell	<-	<-	<-	<-
84-C6	Bell Tree	<-	<-	<-	<-
85-C#6	Castanets	<-	<-	<-	<-
86-D6	Mute Surdo	<-	<-	<-	<-
87-D#6	Open Surdo	<-	<-	<-	<-

GM Backing Instrument List

PIANO

- 1 Acoustic Grand Piano
- 2 Bright Acoustic Piano
- 3 Electric Grand Piano
- 4 Honky-Tonk Piano
- 5 E.Piano 1
- 6 E.Piano 2
- 7 Harpsichord
- 8 Clavi

MALLET

- 9 Celesta
- 10 Glockenspiel
- 11 Music Box
- 12 Vibraphone
- 13 Marimba
- 14 Xylophone
- 15 Tubular Bells
- 16 Dulcimer

ORGAN

- 17 Drawbar Organ
- 18 Percussive Organ
- 19 Rock Organ
- 20 Church Organ
- 21 Reed Organ
- 22 Accordion
- 23 Harmonica
- 24 Tango Accordion

GUITAR

- 25 Nylon Guitar
- 26 Steel Guitar
- 27 Jazz Guitar
- 28 Clean Guitar
- 29 Muted Guitar
- 30 Overdriven Guitar
- 31 Distortion Guitar
- 32 Guitar Harmonics

BASS

- 33 Acoustic Bass
- 34 Finger Bass
- 35 Pick Bass
- 36 Fretless Bass
- 37 Slap Bass 1
- 38 Slap Bass 2
- 39 Synth Bass 1
- 40 Synth Bass 2

STRINGS

- 41 Violin
- 42 Viola

- 43 Cello
- 44 Contrabass
- 45 Tremolo Strings
- 46 Pizzicato Strings
- 47 Orchestral Harp
- 48 Timpan

STRINGS ENSEMBLE

- 49 Strings Ensemble 1
- 50 Strings Ensemble 2
- 51 Synth Strings 1
- 52 Synth Strings 2
- 53 Choir Aahs
- 54 Voice Oohs
- 55 Synth Voice
- 56 Orchestra Hit

BRASS

- 57 Trumpet
- 58 Trombone
- 59 Tuba
- 60 Muted Trumpet
- 61 French Horn
- 62 Brass Section
- 63 Synth Brass 1
- 64 Synth Brass 2

REED

- 65 Soprano Sax
- 66 Alto Sax
- 67 Tenor Sax
- 68 Baritone Sax
- 69 Oboe
- 70 English Horn
- 71 Bassoon
- 72 Clarinet

PIPE

- 73 Piccolo
- 74 Flute
- 75 Recorder
- 76 Pan Flute
- 77 Blown Bottle
- 78 Shakuhachi
- 79 Whistle
- 80 Ocarina

LEAD

- 81 Lead1 (square)
- 82 Lead2 (sawtooth)
- 83 Lead3 (calliope)
- 84 Lead4 (chiff)
- 85 Lead5 (charang)

- 86 Lead6 (voice)
- 87 Lead7 (fifths)
- 88 Lead8 (bass & Lead)

PAD

- 89 Pad1 (newage)
- 90 Pad2 (warm)
- 91 Pad3 (Polysynth)
- 92 Pad4 (choir)
- 93 Pad5 (bowed)
- 94 Pad6 (metallic)
- 95 Pad7 (halo)
- 96 Pad8 (sweep)

EFFECTS

- 97 FX1 (rain)
- 98 FX2 (soundtrack)
- 99 FX3 (crystal)
- 100 FX4 (atmosphere)
- 101 FX5 (brightness)
- 102 FX6 (goblins)
- 103 FX7 (echoes)
- 104 FX8 (sci-fi)

ETHNIC

- 105 Sitar
- 106 Banjo
- 107 Shamisen
- 108 Koto
- 109 Kalimba
- 110 Bagpipe
- 111 Fiddle
- 112 Shanai

PERCUSSIVE

- 113 Tinkle Bell
- 114 Agogo
- 115 Steel Drums
- 116 Wood Block
- 117 Taiko Drum
- 118 Melodic Tom
- 119 Synth Drum
- 120 Reverse Cymbal

SOUND EFFECTS

- 121 Guitar Fret Noise
- 122 Breath Noise
- 123 Seashore
- 124 Bird Tweet
- 125 Telephone Ring
- 126 Helicopter
- 127 Applause
- 128 Gunshot

Pattern List

No.	Name	Type
1	Fusion1	Loop
2	Dance Funk	Loop
3	Modern Pop	Loop
4	Hip Hop	Loop
5	Dance	Loop
6	Classic Rock	Loop
7	6/8 Ballad	Loop
8	Country Pop	Loop
9	Pop Ballad	Loop
10	Break Beat	Loop
11	Fusion2	Loop
12	R&B	Loop
13	Latin Rock	Loop
14	Latin Dance	Loop
15	Funk1	Loop

No.	Name	Type
16	Fusion3	Loop
17	Pop Shuffle	Loop
18	Mambo	Loop
19	Pop Bossa	Loop
20	3/4 Jazz	Loop
21	Rock	Loop
22	Pop Funk	Loop
23	Big Band1	Loop
24	Latin Jazz	Loop
25	Swing	Loop
26	Funky Blues	Loop
27	Funk2	Loop
28	Samba	Loop
29	Big Band2	Loop
30	NuJazz Funk	Loop

Loop List

Number	Name
1	Loop 1
2	Loop 2
3	Loop 3
4	Loop 4
5	Loop 5
6	Loop 6
7	Loop 7
8	Loop 8
9	Loop 9
10	Loop 10
11	Loop 11
12	Loop 12

MIDI Implementation Chart

Function	Transmitted	Recognized	Remarks	
Basic Channel	Default Changed	10ch x	1—16 x	
Mode	Default Messages Altered	x x *****	x x *****	
Note Number	: True Voice	0—127 *****	0—127 0—127	
Velocity	Note On Note Off	○ 99H,V=1-127 ○ (99H,V=0)	○ ○	
after Touch	Key's Ch's	x x	x x	
Pitch Bend		x	x	
Control Change	0 1 5 6 7 10 11 64 65 66 67 80 81 91 93 120 121 123	x x x x x x x x x x x x x x x x x	○ ○ ○ ○ ○ ○ ○ ○ ○ ○ ○ ○ ○ ○ ○ ○ ○ ○	Bank Select Modulation Portamento Time Data Entry Volume Pan Expression Sustain Pedal Portamento On/Off Sostenuto Pedal Soft Pedal Reverb Program Chorus Program Reverb Level Chorus Level All Sound Off Reset All Controllers All Notes Off
Program Change	: True Number	x xxxxxxx	○ 0-127	
System Exclusive		x	○	
System Common	: Song Position : Song Select : Tune	x x x	x x x	
System Real Time	: Clock : Commands	○ ○	x x	Start And Stop Only
Aux Messages	: Local On/off : All Notes Off : Active Sensing : Reset	x x x x	x x x x	

